

MONTAGEANLEITUNG

SHAPELINE FAHRTRICHTUNGSANZEIGER/VORDERE BLINKLICHT WING STYLE

INSTALLATION INSTRUCTION

SHAPELINE FRONT DIRECTION INDICATOR WING STYLE

INSTRUCTIONS DE MONTAGE

SHAPELINE FEU CLIGNOTANT AVANT WING STYLE

MONTERINGSANVISNING

SHAPELINE BLINKLJUS FRAM WING STYLE

MONTAGEHANDLEIDING

SHAPELINE VOORSTE KNIPPERLICHT WING STYLE

INSTRUCCIONES DE MONTAJE

SHAPELINE LUZ INTERMITENTE DELANTERA WING STYLE

ISTRUZIONI DI MONTAGGIO

SHAPELINE INDICATORE DI DIREZIONE ANTERIORE WING STYLE

ASENNUSOHJE

SHAPELINE ETUVILKKUVALO WING STYLE

DE Technische Änderungen vorbehalten

EN Subject to alteration without notice

FR Sous réserve de modifications techniques

SV Vi reserverar oss för tekniska ändringar

NL Technische wijzigingen voorbehouden

ES Reservadas modificaciones técnicas

IT Con riserva di modifiche tecniche

FI Oikeus teknisiin muutoksiin pidätetään

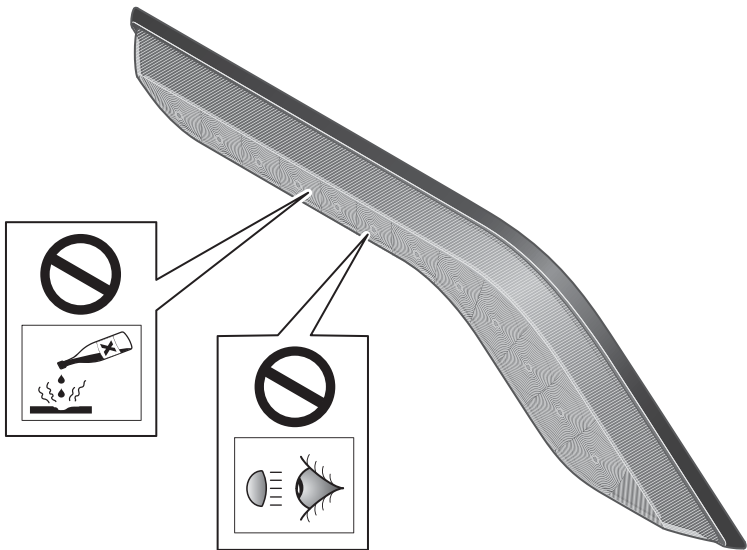

Produkthaftung

- Es sind die nationalen Anbau-, Einbau- und Betriebsvorschriften zu beachten und einzuhalten.
- Lesen Sie bitte vor Gebrauch des Gerätes alle beigelegten Anleitungen und Sicherheitshinweise.
- Im Zuge von Produktverbesserung behalten wir uns technische und optische Änderungen vor.
- Verwenden Sie nur die Originalersatzteile bzw. nur Ersatzteile die von HELLA freigegeben sind.
- Bei Fragen oder Einbauproblemen, rufen Sie den HELLA Kundendienst, Großhändler oder wenden Sie sich an Ihre Vertragswerkstatt.

Product liability

- National mounting, fitting and operating regulations must be heeded and kept.
- Please read all the instructions and safety notes included before using the device.
- We reserve the right to make technical and optical modifications within the course of product improvement.
- Only use original spare parts or spare parts approved by HELLA.
- If you have any questions or installation problems, call HELLA customer services, your wholesaler or contact your specialist garage.

Responsabilité produit

- Les prescriptions nationales en matière de montage et de service doivent être observées et respectées.
- Avant d'utiliser l'appareil lire toutes les instructions de montage et de service fournies ainsi que les conseils de sécurité.
- Dans le cadre de l'amélioration continue de nos produits, nous nous réservons le droit de réaliser des modifications sur les plans technique et optique.
- Utilisez uniquement des pièces d'origine ou des pièces de rechange validées par HELLA.
- Pour tous renseignements ou problèmes de montage, contactez le S.A.V. HELLA, votre distributeur ou votre garage lié par contrat.

Produktansvar

- De nationella monterings-, installations- och driftföreskrifterna ska beaktas och följas.
- Läs alla medföljande instruktioner och säkerhetsanvisningar innan du använder apparaten.
- Vi förbehåller oss rätten till tekniska och optiska ändringar som förbättrar produkten.
- Använd endast original reservdelar resp. endast reservdelar som har godkänts av HELLA.
- Om du har frågor eller problem med installationen, ring HELLA kundtjänst, partihandlaren eller vänd dig till din märkesverkstad.

Productaansprakelijkheid

- Men dient de nationale aanbouw-, inbouw- en bedrijfsvoorschriften in acht te nemen en na te leven.
- Lees a.u.b. alvorens het apparaat te gebruiken alle bijgevoegde gebruiksaanwijzingen en veiligheidsinstructies door.
- In het kader van de productverbetering behouden wij ons technische en optische veranderingen voor.
- Gebruiksluitende originele reserveonderdelen, die door Hella vrijgegeven zijn.
- Bij vragen of inbouwproblemen dient u de HELLA klantenservice, de groothandel te bellen of u te richten tot de dealerwerkplaats.

Responsabilidad civil por productos defectuosos

- Tienen que observarse y cumplirse con las prescripciones nacionales sobre construcciones anexas, de montaje y de funcionamiento
- Rogamos que antes de usar el aparato lean todas las instrucciones y advertencias sobre la seguridad adjuntas.
- En aras de la mejora de los productos, nos reservamos el derecho de hacer modificaciones técnicas y ópticas.
- Use sólo recambios originales o bien sólo recambios autorizados por HELLA.
- Si tiene preguntas que hacer o dificultades en el montaje, llame al Servicio de Atención al Cliente de HELLA, a los mayoristas o diríjase a su taller concesionario.

Responsabilità per il prodotto

- Si devono rispettare tutte le normative nazionali di attacco, montaggio e funzionamento.
- Prima di usare l'apparecchio, legga per favore tutte le istruzioni e le avvertenze di sicurezza allegate.
- Nell'ambito del perfezionamento del prodotto, ci riserviamo modifiche tecniche ed estetiche.
- Utilizzate solo pezzi di ricambio originali risp. pezzi autorizzati dalla HELLA.
- In caso di domande o problemi di montaggio, chiamate il servizio di assistenza dei clienti della HELLA, il rivenditore o si rivolga alla Sua officina autorizzata.

Tuotevastuu

- Kansalliset asennus- ja käyttöohjeet on huomioitava ja niitä on noudatettava.
- Lue ennen laitteen käyttöä kaikki oheistetut käyttö- sekä turvaohjeet.
- Jatkuvasta tuotekehittelystä johtuen pidätämme oikeuden teknisiin ja optisiin muutoksiin.
- Käytä vain alkuperäisiä tai HELLA hyväksymiä varaosia.
- Jos Sinulla on kysymyksiä tai asennusongelmia, soita HELLA-asiakaspalveluun, tukkukauppiaille tai käänny sopimuskorjaamon puoleen.

Zeichenerklärung
Explanation symbols
Explication des symboles

Symbolförklaring
Legenda
Aclaración de símbolos

Legenda
Piirroksen selitys



- DE** Richtig
- EN** Correct
- FR** Correct
- SV** Rätt
- NL** Goed
- ES** Correcto
- IT** Giusto
- FI** Oikein



- DE** Falsch
- EN** Incorrect
- FR** Incorrect
- SV** Fel
- NL** Fout
- ES** Erróneo
- IT** Sbagliato
- FI** Väärin



- DE** Positionspfeil
- EN** Location/Position Arrow
- FR** Flèche de Position
- SV** Positionpil
- NL** Lokatie/Positie pijl
- ES** Flecha de posición
- IT** Freccia di posizione
- FI** Paikannusnuoli



- DE** Bewegungspfeil
- EN** Movement Arrow
- FR** Flèche indiquant sens du mouvement
- SV** Rörelsepil
- NL** Richtingspijl
- ES** Flecha de movimiento
- IT** Freccia di movimento
- FI** Liikesuuntanuoli



- DE** Achtung
- EN** Warning
- FR** Attention
- SV** Varning
- NL** Let op
- ES** Atención
- IT** Attenzione
- FI** Huomio



- DE** Abklemmen
- EN** Disconnect
- FR** Déconnecter
- SV** Koppla los
- NL** Demonteren
- ES** Desconectar
- IT** Staccare
- FI** Irrota



- DE** Verbinden
- EN** Connect
- FR** Connecter
- SV** Anslut
- NL** In elkaar
- ES** Conectar
- IT** Collegare
- FI** Yhdistä



- DE** Siehe
- EN** Look/See
- FR** Voir
- SV** Se
- NL** Kijken naar
- ES** Ver
- IT** Vedere
- FI** Katso

Lieferumfang
Scope of delivery
Fourniture

Leveransomfatning
Leveringsomvang
Alcance de suministro

Contenuto della confezione
Toimituksen sisältö

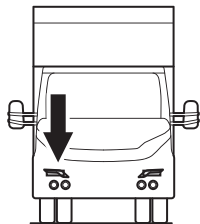

2BA 013 334-02

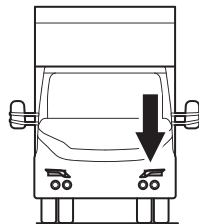
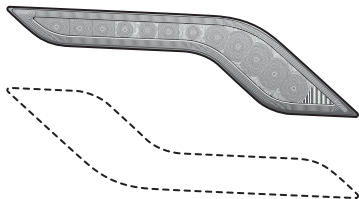

2BA 013 334-01

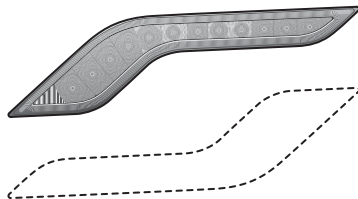

Benötigte Montagewerkzeuge
Installation tools required
Outillage de montage requis

Nödvändiga monteringsverktyg
Benodigde montagewerktuigen
Herramientas de montaje necesarias

Attrezzi necessari per il montaggio
Tarvittavat asennustyökalut

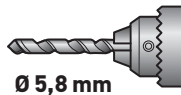

Ø 5,8 mm

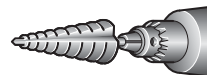

Ø 26 mm
Ø 30 mm



M5

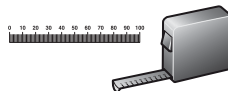

Montage
Mounting
Montage Général

Montering
Montage
Montaje

Montaggio
Asennus

ECE-R 7
ECE-R 48

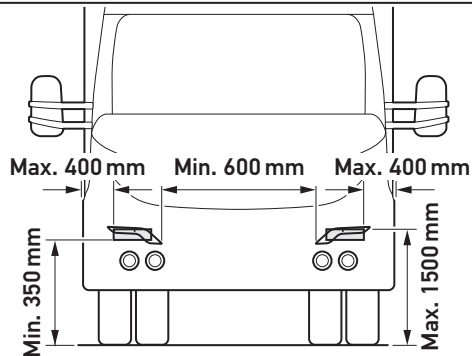
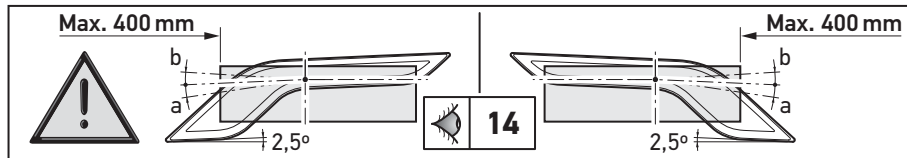



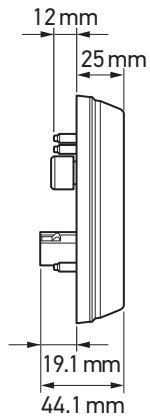
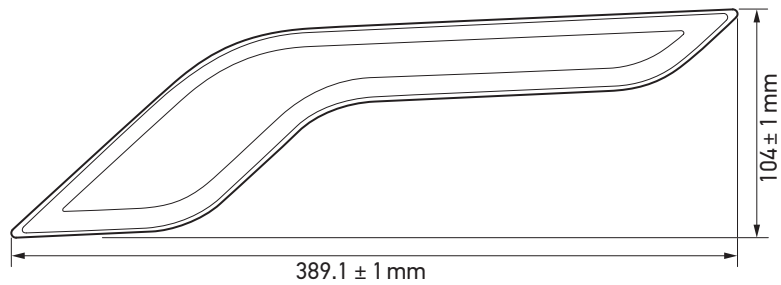

12

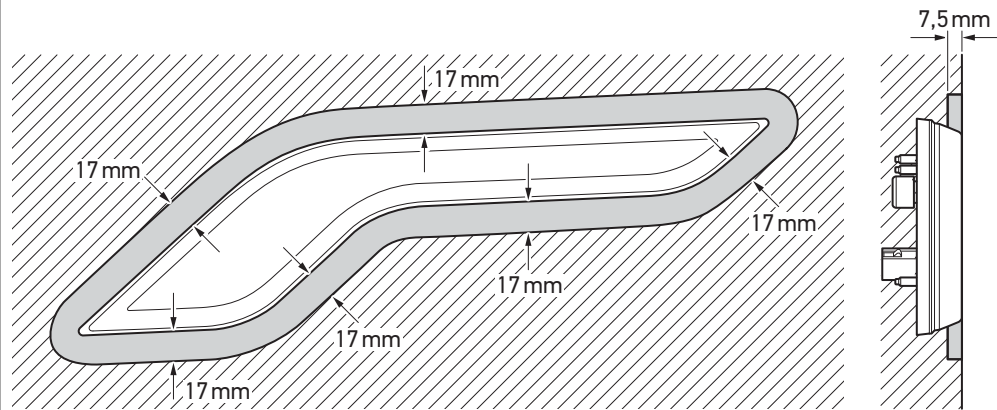

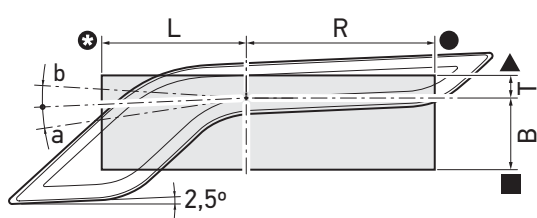



13



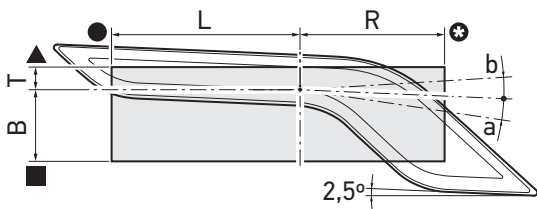

	 (T)mm	 (B)mm	 (L)mm	 (R)mm
$a = b = 0^\circ$	18	57	115	150
$a = 6^\circ$	34	65	109	147
$b = 6^\circ$	12	41	112	144



	 (T)mm	 (B)mm	 (R)mm	 (L)mm
$a = b = 0^\circ$	18	57	115	150
$a = 6^\circ$	34	65	109	147
$b = 6^\circ$	12	41	112	144

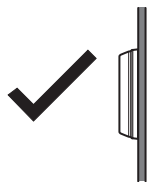
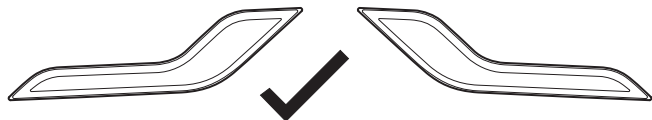
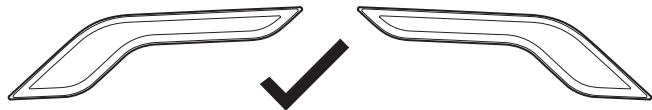

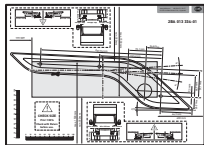
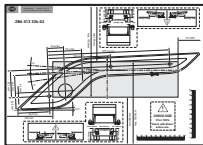
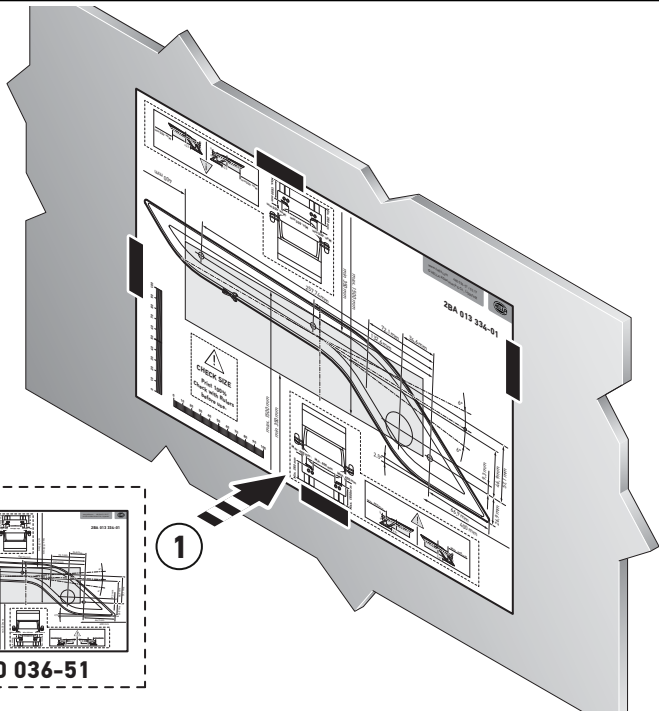
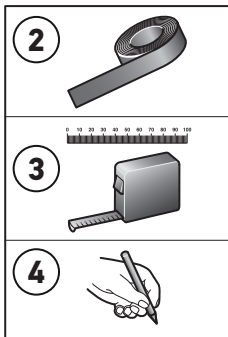

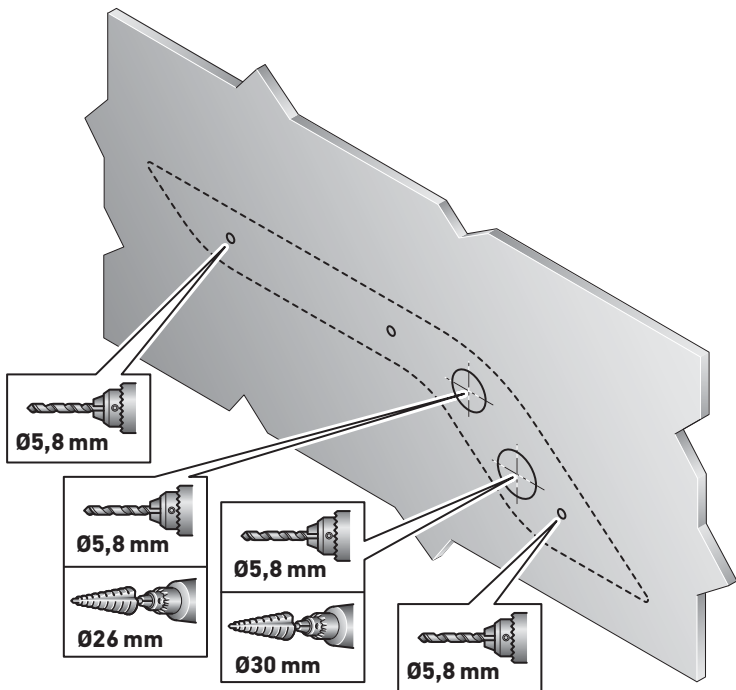
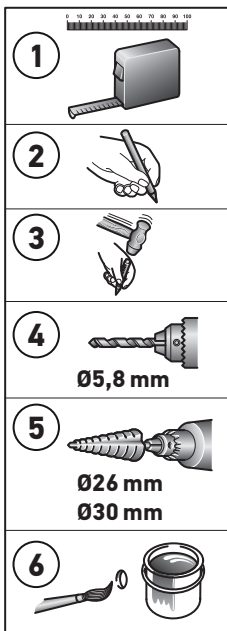

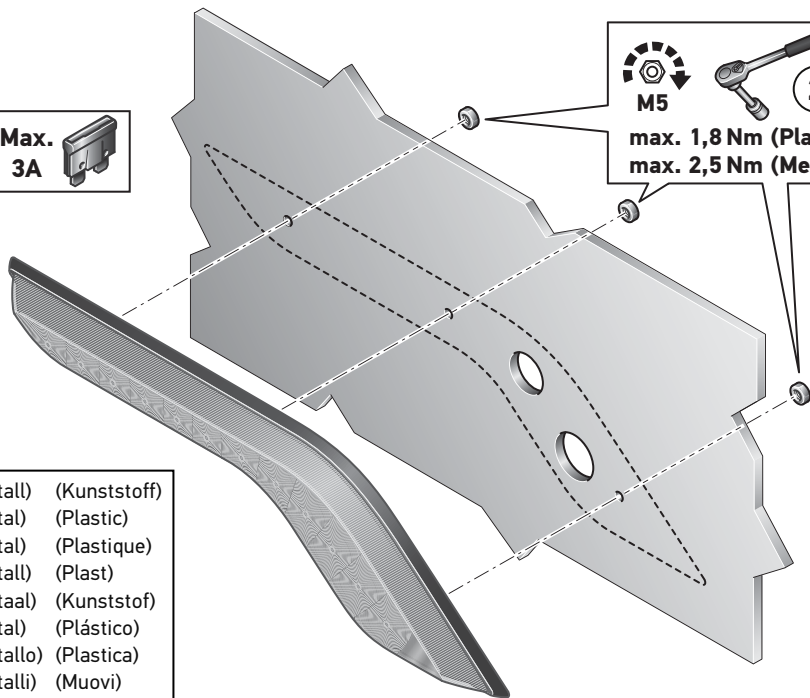
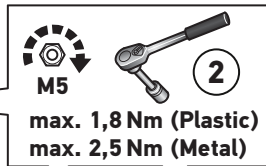
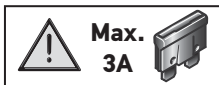

DE	(Metall)	(Kunststoff)
EN	(Metal)	(Plastic)
FR	(Métal)	(Plastique)
SV	(Metall)	(Plast)
NL	(Metaal)	(Kunststof)
ES	(Metal)	(Plástico)
IT	(Metallo)	(Plastica)
FI	(Metalli)	(Muovi)

Elektrischer Anschluss
Electrical connection
Branchement électrique

Elektrisk anslutning
Elektrische aansluiting
Conexión eléctrica

Collegamento elettrico
Osaluettelo

19

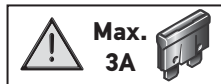

Fahrtrichtungsanzeiger/
vordere Blinklicht
Front Direction Indicator
Feu clignotant avant
Blinkljus fram
Voorste knipperlicht
Luz intermitente delantera
Indicatore di direzione anteriore
Etuvilkkuvalo



CLICK

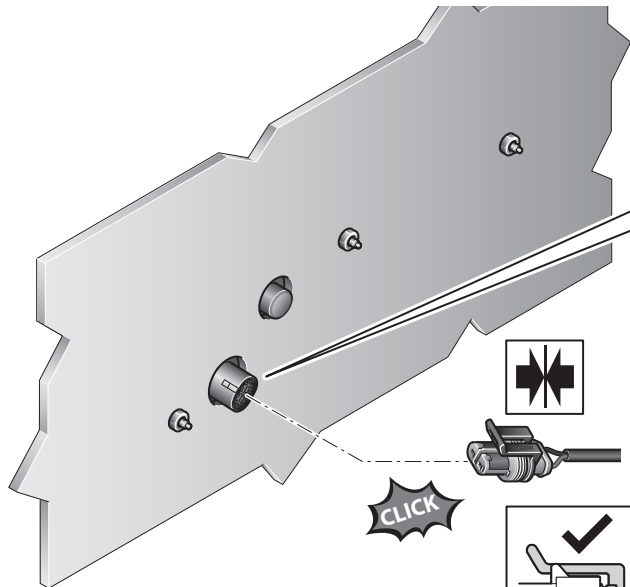
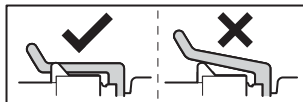

Elektrischer Anschluss
Electrical connection
Branchement électrique

Elektrisk anslutning
Elektrische aansluiting
Conexión eléctrica

Collegamento elettrico
Osaluettelo

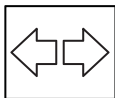

ISO 13207

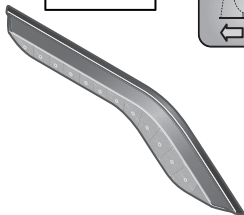
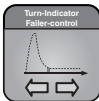

Fahrtrichtungsanzeiger/
vordere Blinklicht
Front Direction Indicator
Feu clignotant avant
Blinkljus fram
Voorste knipperlicht
Luz intermitente delantera
Indicatore di direzione anteriore
Etuvilkkuvalo

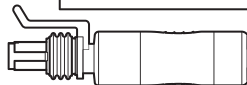
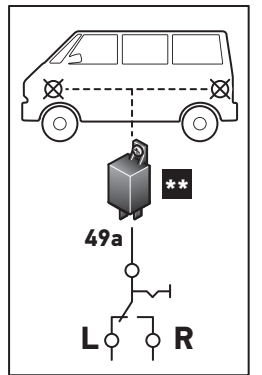
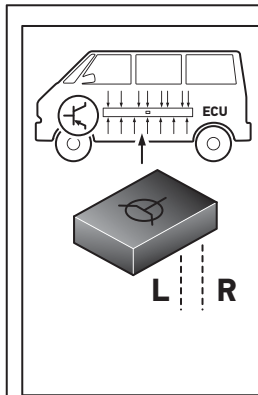

Max.
3A



12V = 009 492-111
24V = 009 492-011

DE Informationstext	22
EN Information Text	22
FR Texte d'information	22
SV Informationstext	23
NL Informatie tekst	23
ES Texto informativo	23
IT Informazioni	24
FI Ohjetekstit	24

DE TECHNISCHE DATEN

Nennspannung	Spannungsbereich	Eingangswerte	Zulässige Umgebungstemperatur	Schutzklasse
12 V	9V -16 V	< 5,5W	-40° C bis +60° C	IP 6K7, IP X9K
24 V	18V -32 V			

Der Betrieb der Leuchte mit Wechselspannung oder getakteter Gleichspannung ist nicht zulässig!

EN TECHNICAL DATA

Nominal voltage	Range of voltage	Input values	Admissible ambient temperature	Class of protection
12 V	9V -16 V	< 5,5W	-40°C up to +60°C	IP 6K7, IP X9K
24 V	18V -32 V			

Operation of the light using alternating voltage or clocked direct voltage is not permitted!

FR DOCUMENT TECHNIQUE

Tension nominale	Valeurs d'entrée	Valeurs d'entrée	Température ambiante admissible	Classe de protection
12 V	9V -16 V	< 5,5W	-40°C à +60°C	IP 6K7, IP X9K
24 V	18V -32 V			

Le fonctionnement du feu avec une tension alternative ou une tension continue cadencée n'est pas admis!

SV TEKNISKA DATA

Märk-spänning	Spänning-sområde	Ingångsvärden	Tillåten omgivnings-temperatur	Skyddsklass
12V	9V -16V	< 5,5W	-40°C upp till +60°C	IP 6K7, IP X9K
24V	18V -32V			

Lampan får inte användas med växelspanning eller taktad likspanning!

NL TECHNISCHE GEGEVENS

Nominale spanning	Spannings-bereik	Ingangswaarden	Toegestane omgevings-temperatuur	Beschermklasse
12V	9V -16V	< 5,5W	-40°C tot +60°C	IP 6K7, IP X9K
24V	18V -32V			

Het gebruik van de lamp met wisselspanning of getacte gelijkspanning is niet toegestaan!

ES DATOS TÉCNICOS

Tensión nominal	Margen de tensión	Valores de entrada	Temperatura ambiente admisible	Clase de protección
12V	9V -16V	< 5,5W	-40°C hasta +60°C	IP 6K7, IP X9K
24V	18V -32V			

¡No es admisible el funcionamiento de las luces con corriente alterna o corriente continua sincronizada!

IT DATI TECNICI

Tensione nominale	Intervallo di tensione	Valori di ingresso	Temperatura ambiente ammessa	Categoria di protezione
12V	9V -16V	< 5,5W	da -40°C a +60°C	IP 6K7, IP X9K
24V	18V -32V			

Non è consentito attivare i fanali con tensione alternata o tensione continua ciclica!

FI TEKNISET TIEDOT

Nimellis-jännite	Jännitealue	Tuloarvot	Sallittu ympäristölämpötila	Kotelointiluokka
12V	9V -16V	< 5,5W	-40°C ... +60°C	IP 6K7, IP X9K
24V	18V -32V			

Valoa ei saa käyttää vaihtojännitteellä eikä tahdistetulla tasajännitteellä!

DE Beleuchtungsanlage auf einwandfreie Funktion hin prüfen

EN Check that the lighting system is working perfectly

FR Contrôler le bon fonctionnement de l'installation d'éclairage

SV Kontrollera att ljussystemet fungerar felfritt

NL Controleer of de verlichting goed functioneert

ES Comprobar que el sistema de iluminación funciona impecablemente

IT Controllare la perfetta funzionalità dell'impianto di illuminazione

FI Tarkasta valaistusjärjestelmän toiminta

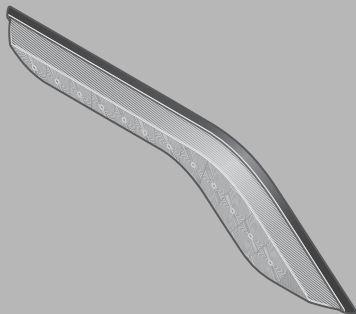

HELLA KGaA Hueck & Co.

Rixbecker Straße 75

59552 Lippstadt / Germany

www.hella.com

© HELLA KGaA Hueck & Co., Lippstadt

460 035-29 / 05.17