

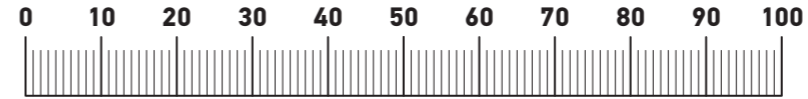

# 2BA 013 333-05



**CHECK SIZE**

Print 100%  
Check with Rulers  
before use.

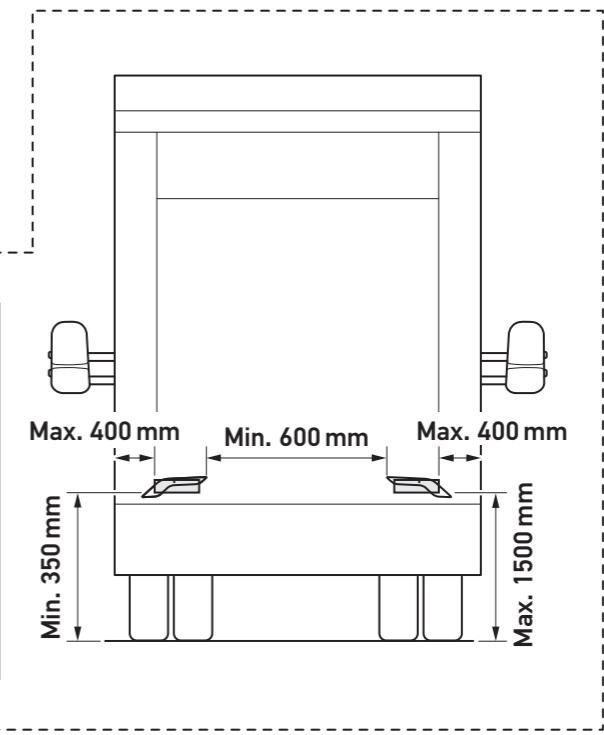
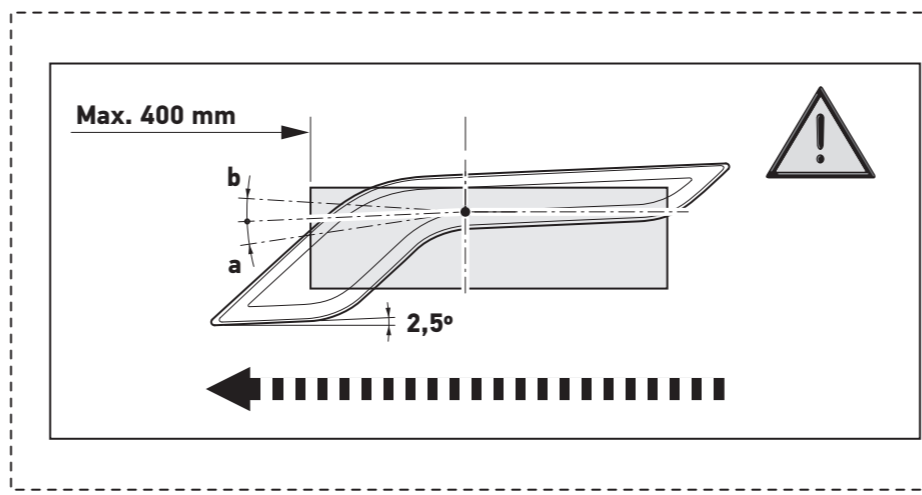
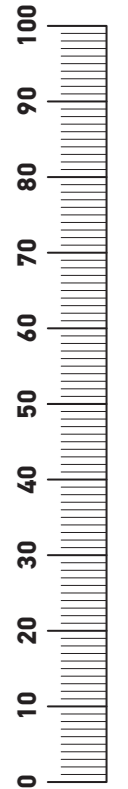
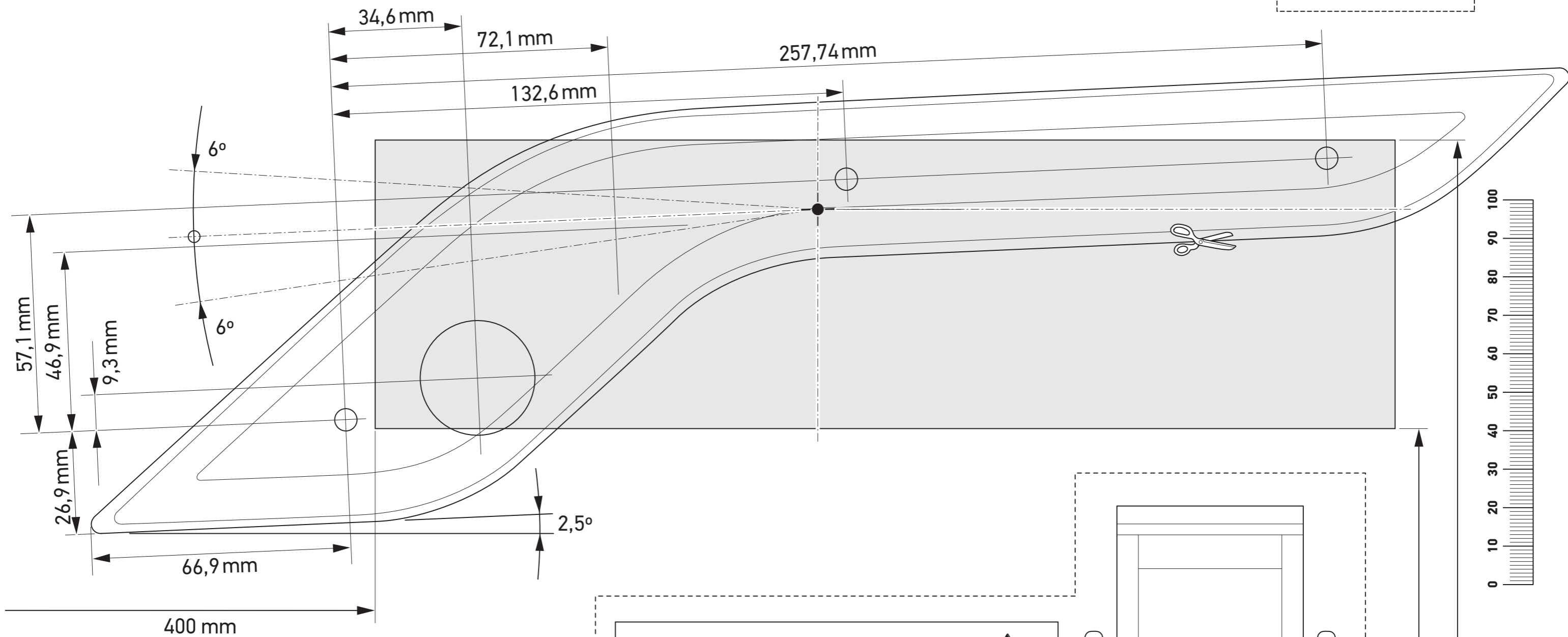

min 350 mm  
max. 1500 mm