

L = 215

TRUSTING

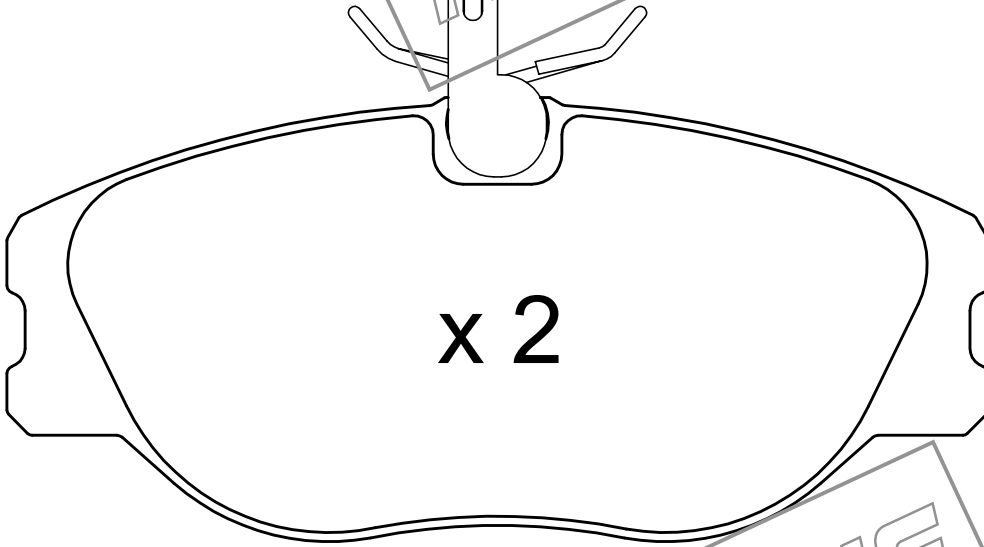

x 2

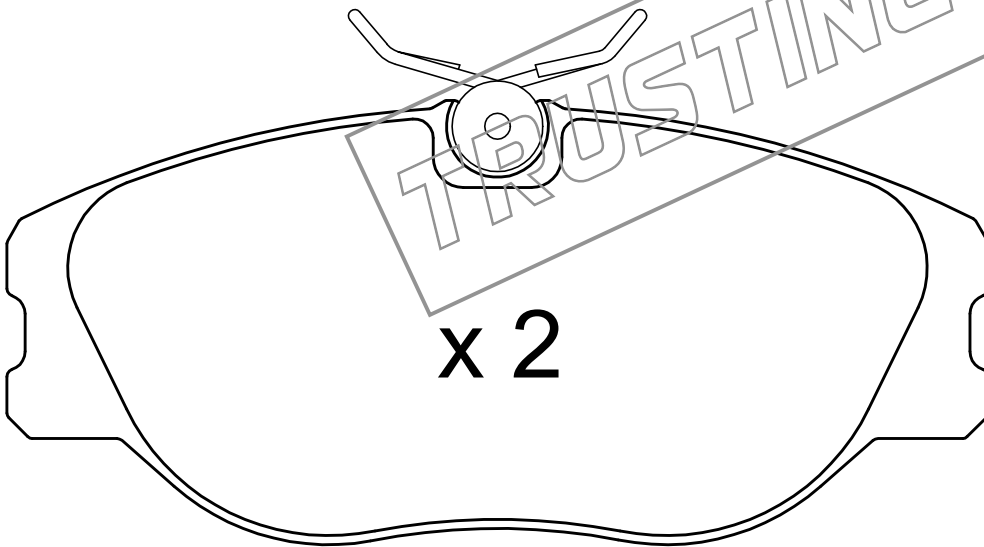

x 2

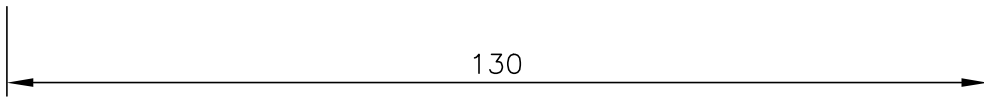

130

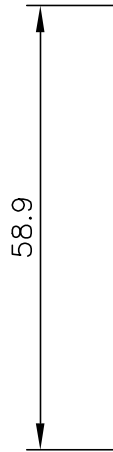
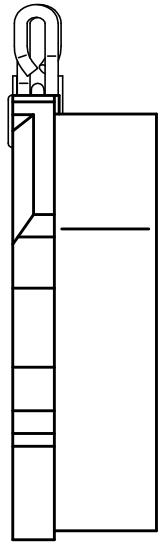
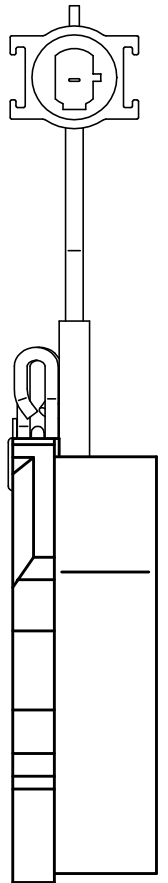

58.9

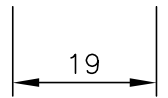

19

TRUSTING