

x 2

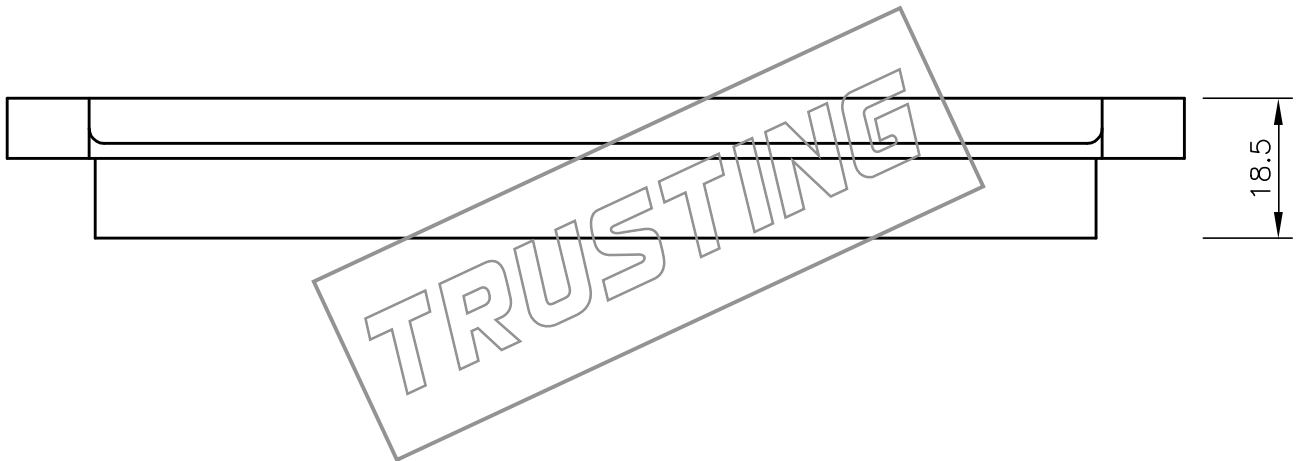

L = 325

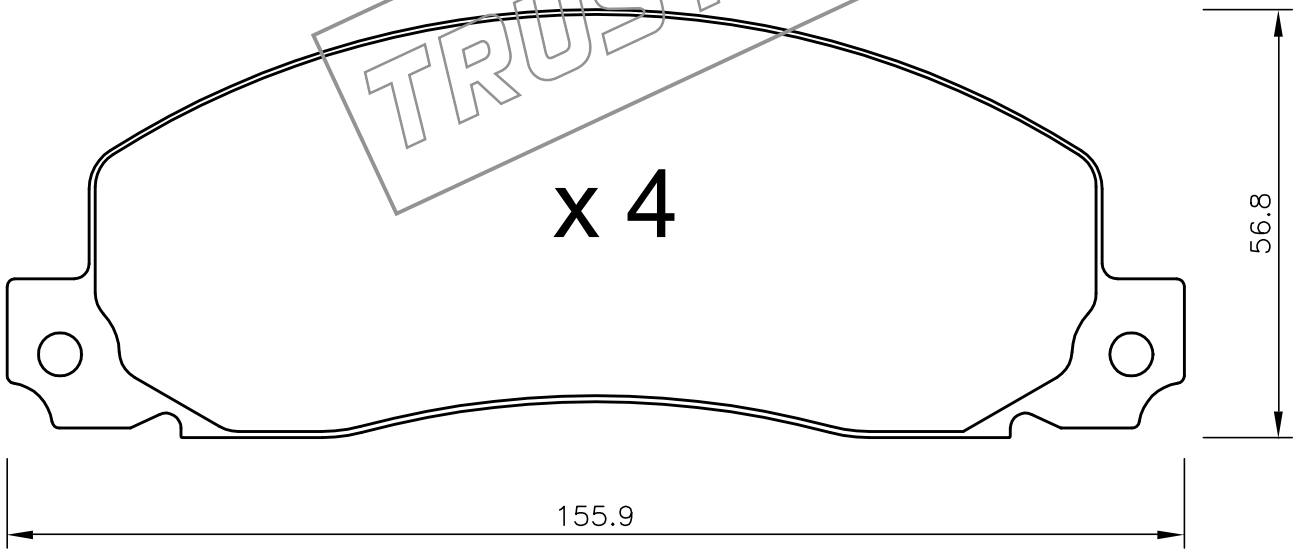

TRUSTING