

L = 205

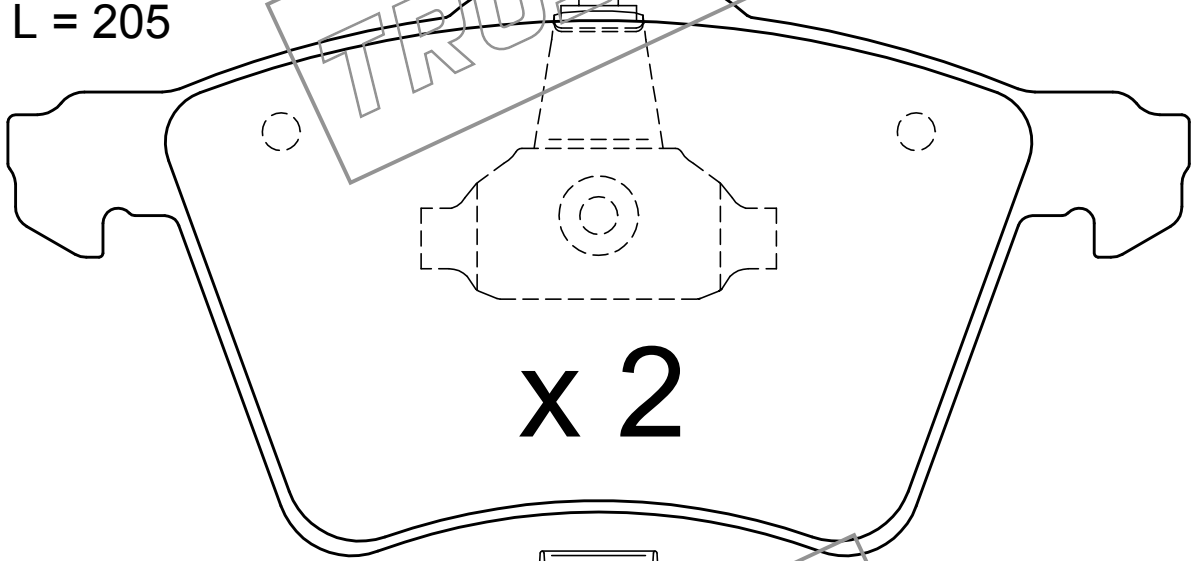

x 2

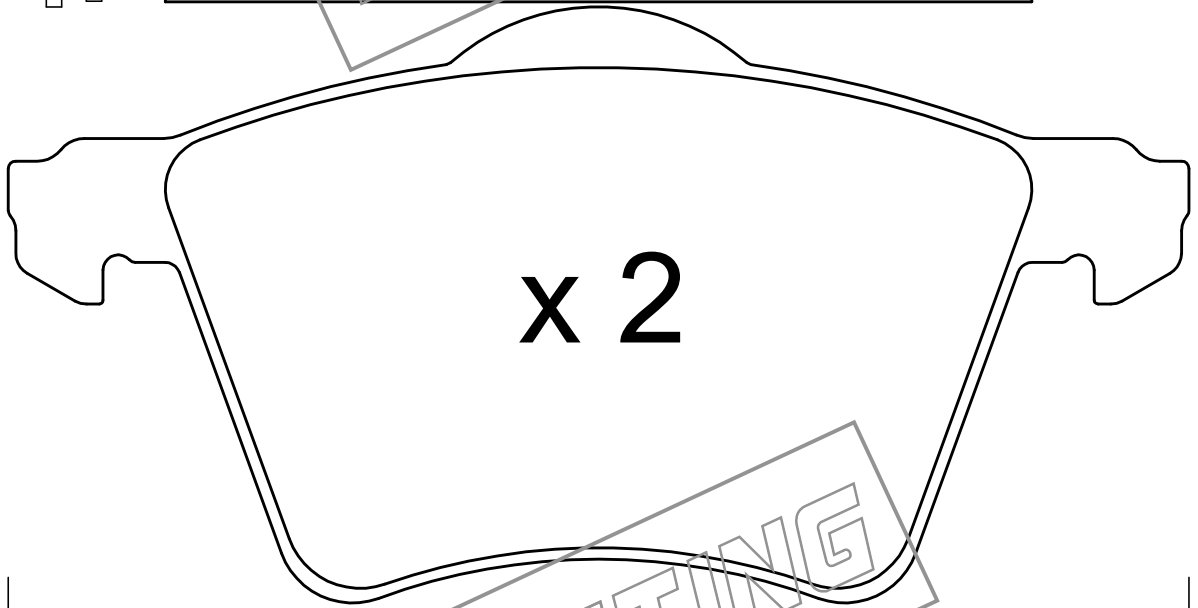
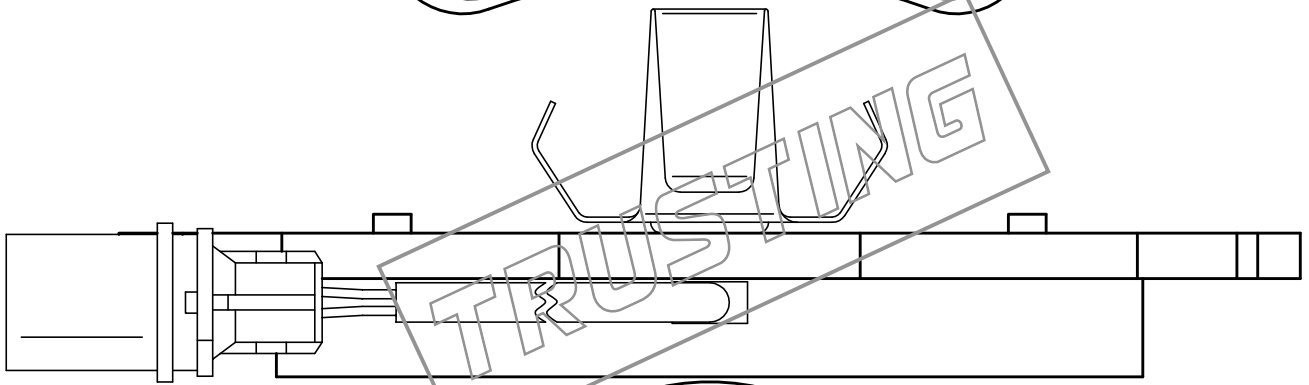

x 2

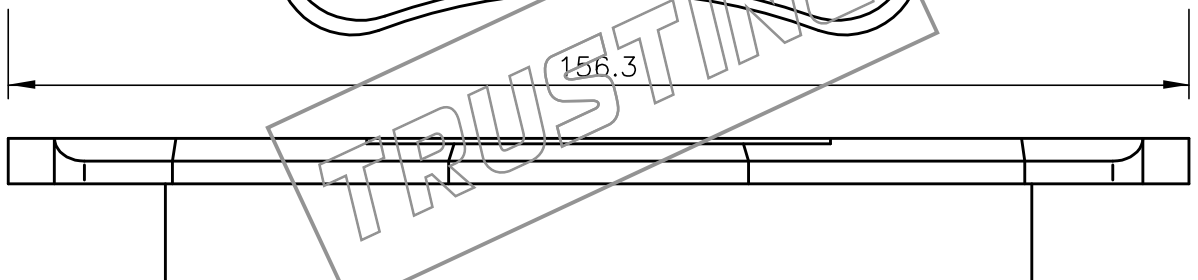

156.3

78.9

19