

x 2

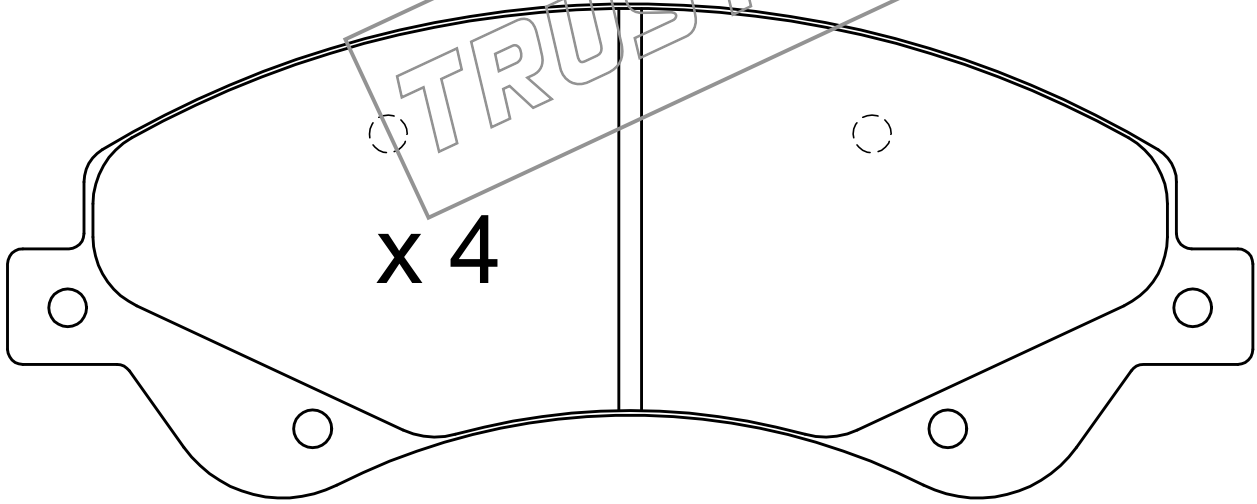

L = 250

x 4



65.4

164.7

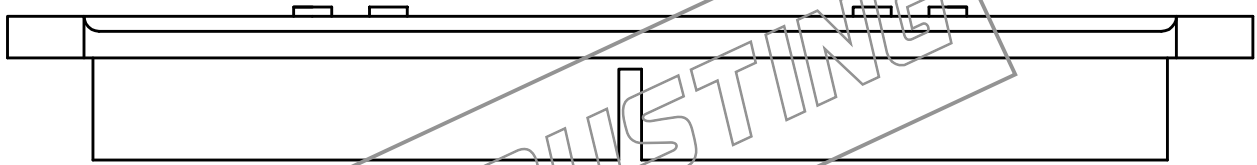
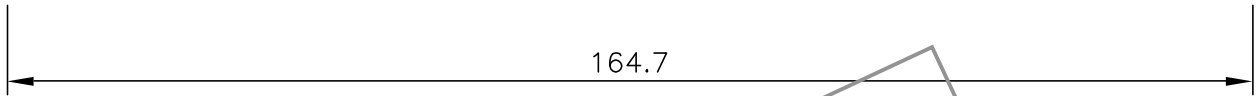

19

TRUSTING