

Wiringkit

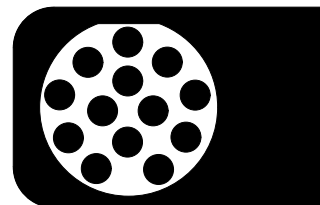

- D Einbauanleitung
- GB Installation instructions
- F Consignes de montage
- NL Montagehandleiding
- DK Montagevejledning
- N Monteringsinstruksjon
- S Installationsanvisning
- FIN Asennusohje
- I Istruzioni per il montaggio
- E Instrucciones de montaje
- P Instruções de montagem
- GR Οδηγίες εγκατάστασης
- CZ Návod k montáži
- SLO Navodilo za vgradnjo
- SK Montážny návod
- PL Instrukcja montażu
- TR Montaj talimatı
- H Beépítési útmutató
- HR Upute o ugradnji
- BUL Инструкция за монтаж
- RO Instrucțiuni de montaj
- RU Инструкция по монтажу и установке
- LT Montavimo informacija
- LV Iemontēšanas pamācība
- EST Paigaldusjuhend

701504 SEAT

- Leon 5F SC/5 Door 02/13
- Leon 5F ST 11/13

PR: 1D0 / 1D8 / 1M5

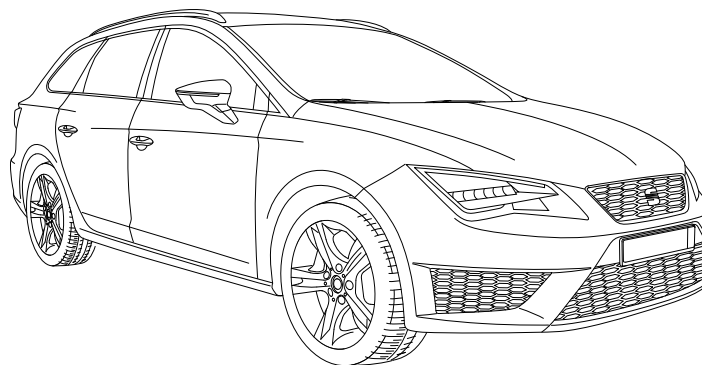
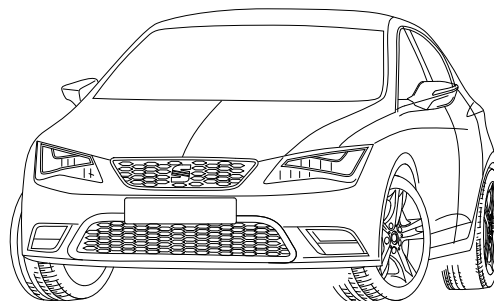

INFORMATION

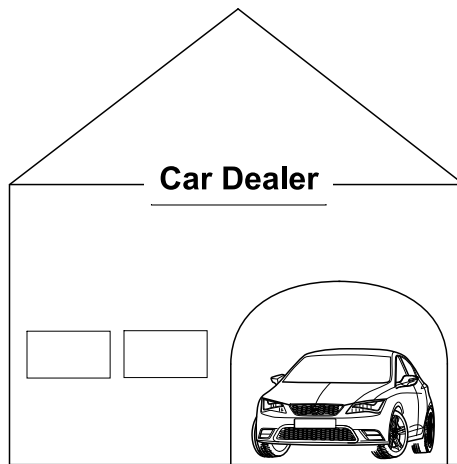

oder / or

Serviceplan

1. VSSZZZ 5F Z

2. 5F1 5TY
LEON 2.0 CR
FR 5T135 DK7AU6

3. CUNA

LY9T CP

4.

X0A	B0A	DK7	G1A	1AT	8GU
J2D	C0T	H7D	—	1G9	1NL
I8H	8ZH	9VD	8IT	8WH	8TB
Q4H	4A3	2PK			
1D0	2B2	—	5SJ	5RQ	QG1
7MM	G03				

5. 5.5 4.0 4.5
— — 119

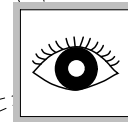
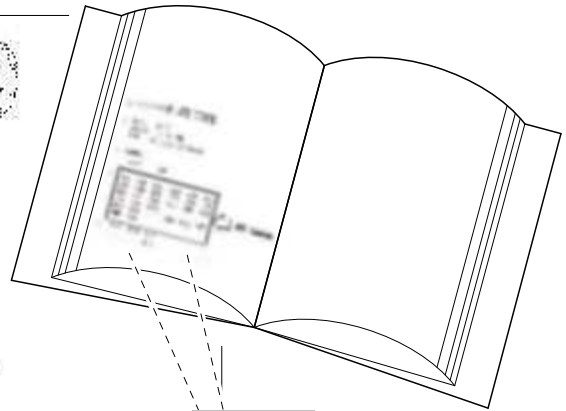

PR: Codes

OVERVIEW

For vehicles with trailer preparation PR: 1D8 / 1M5

PR: 1D8
>> 05/14

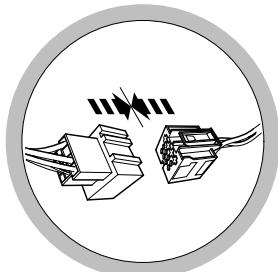

I

PR: 1M5

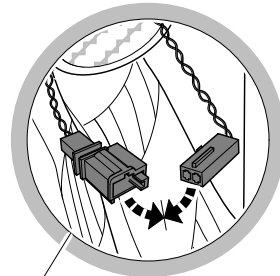

PR: 1D8
06/14 >>

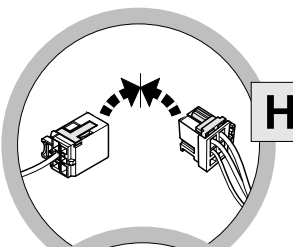

H

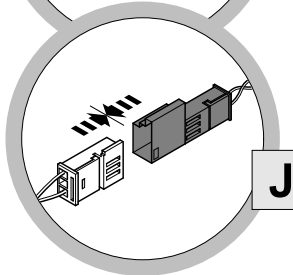

J

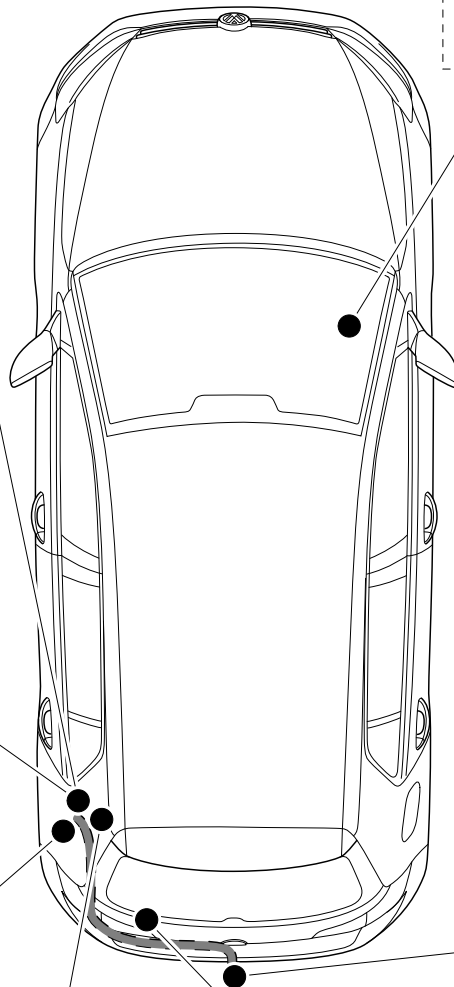

A B C

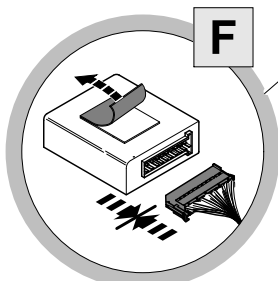
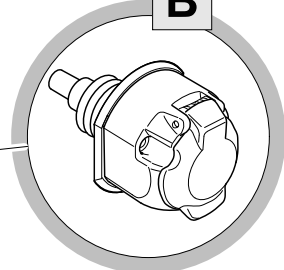

F

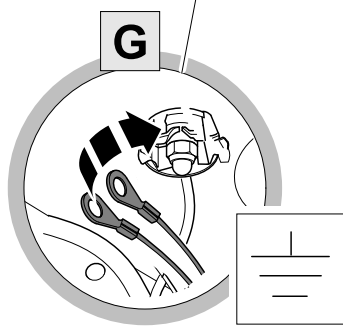

G

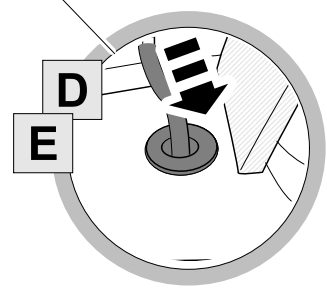

D

E

OVERVIEW

For vehicles without trailer preparation PR: 1D0

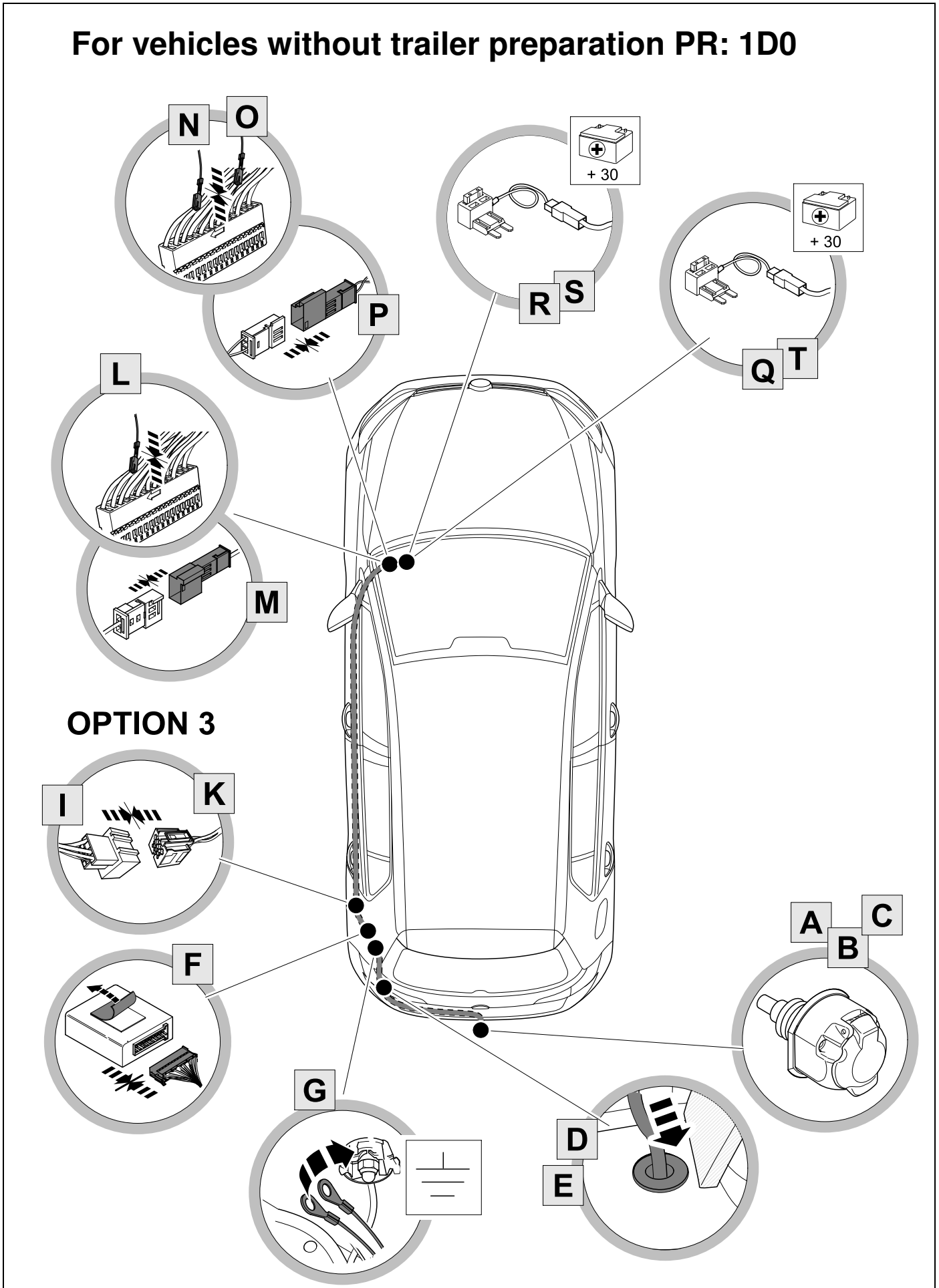

KIT

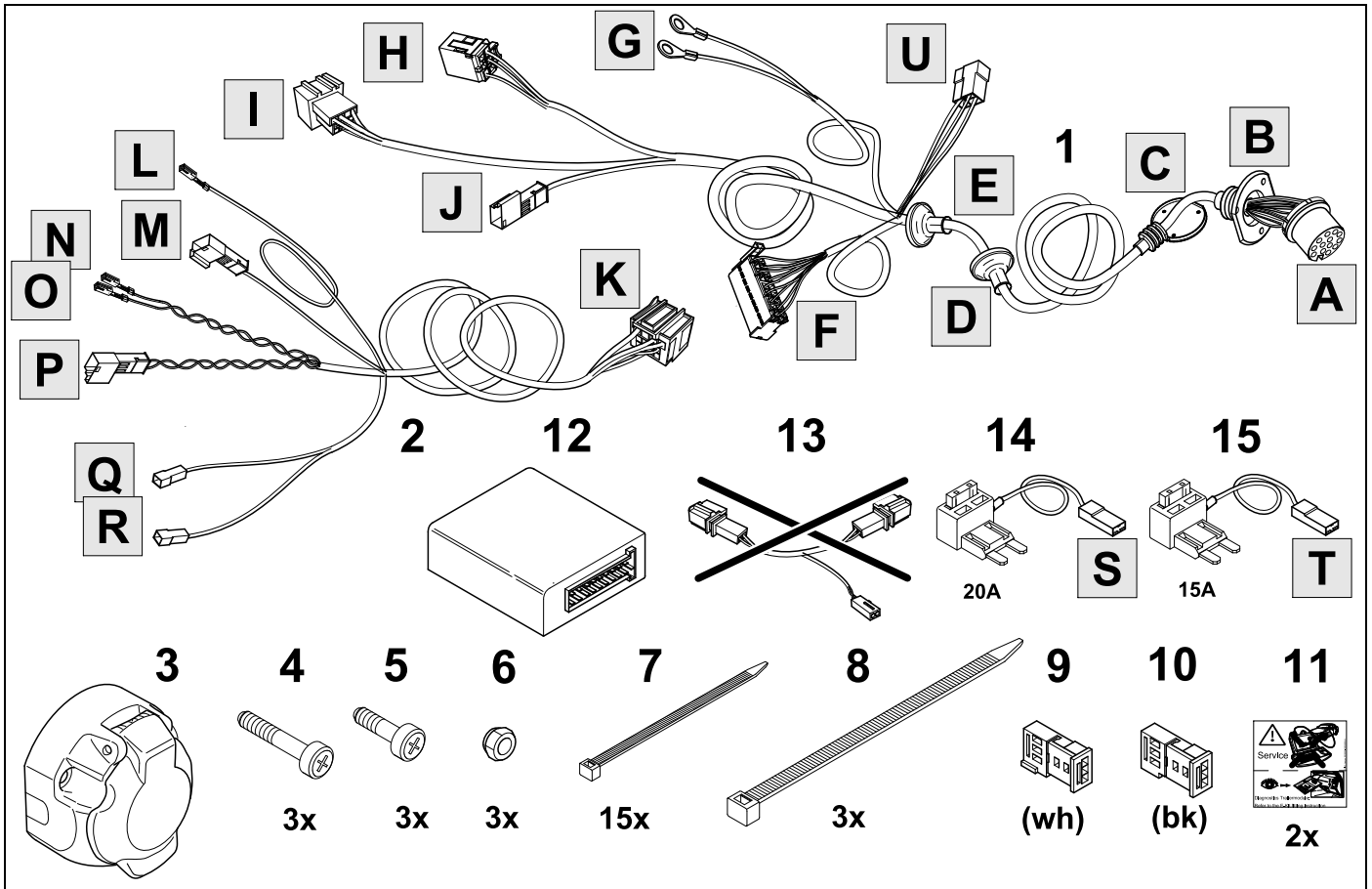

TOOLS

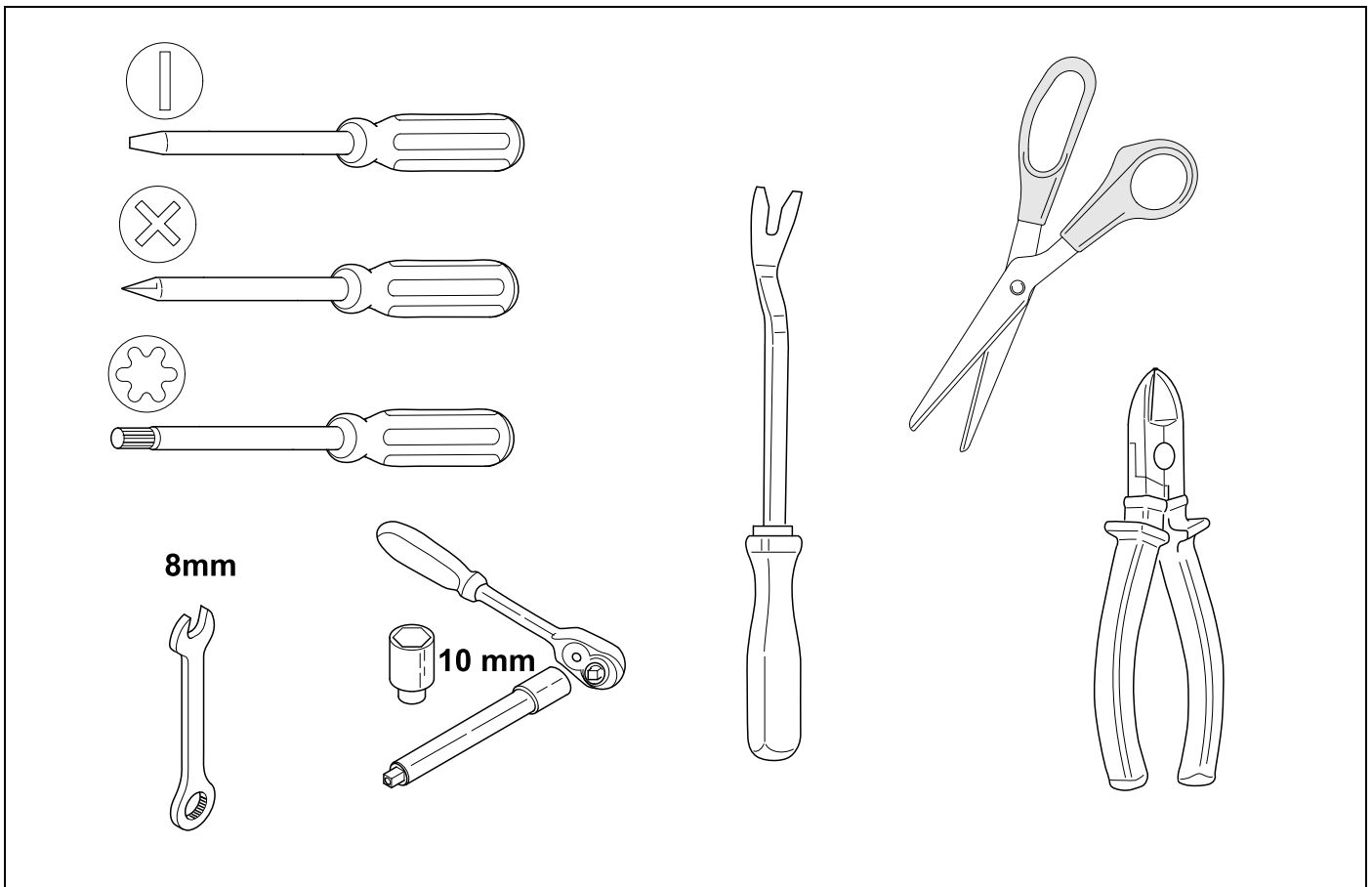

1

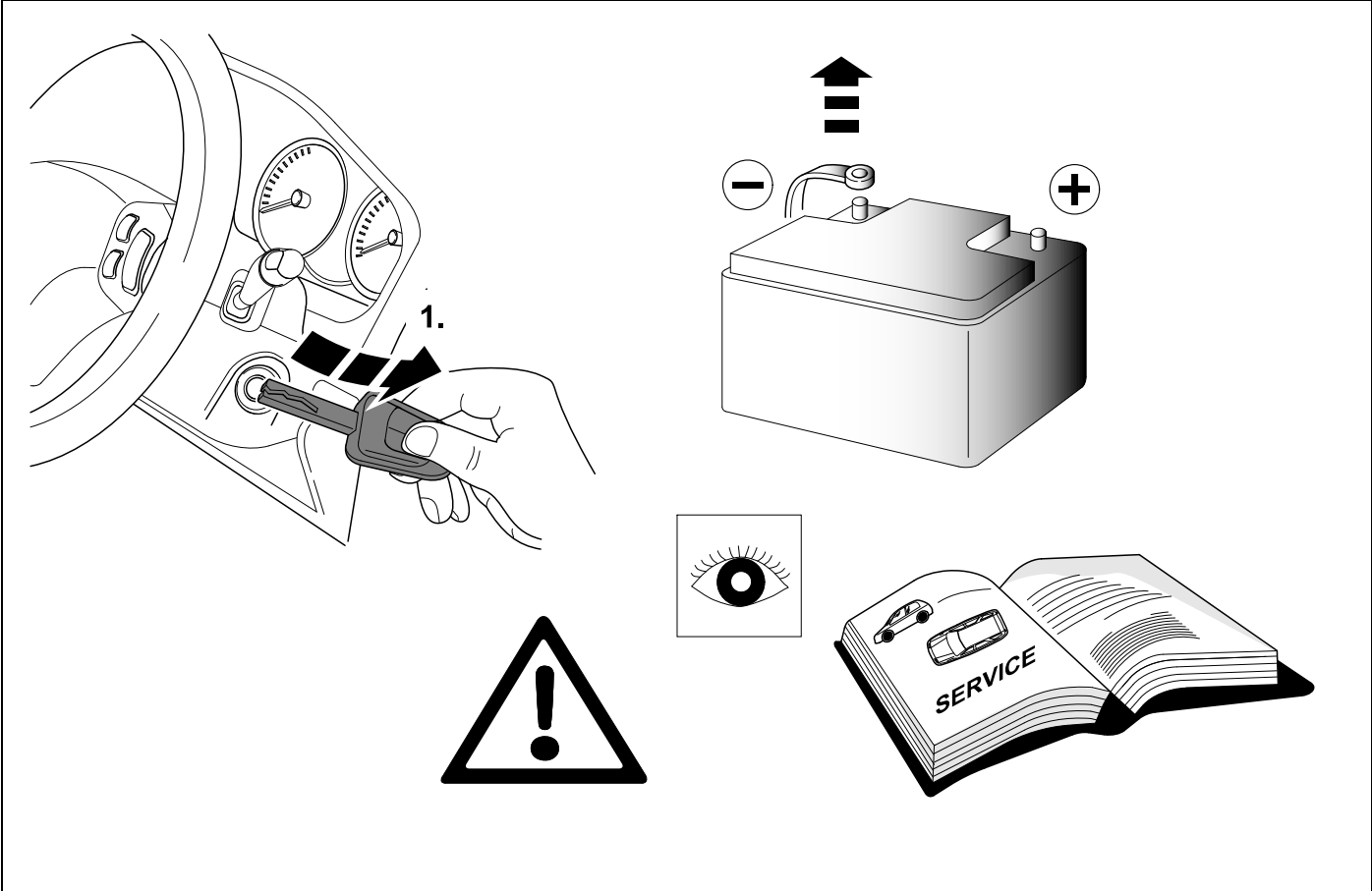

2 REMOVE

Leon PR: 1D8 / 1M5

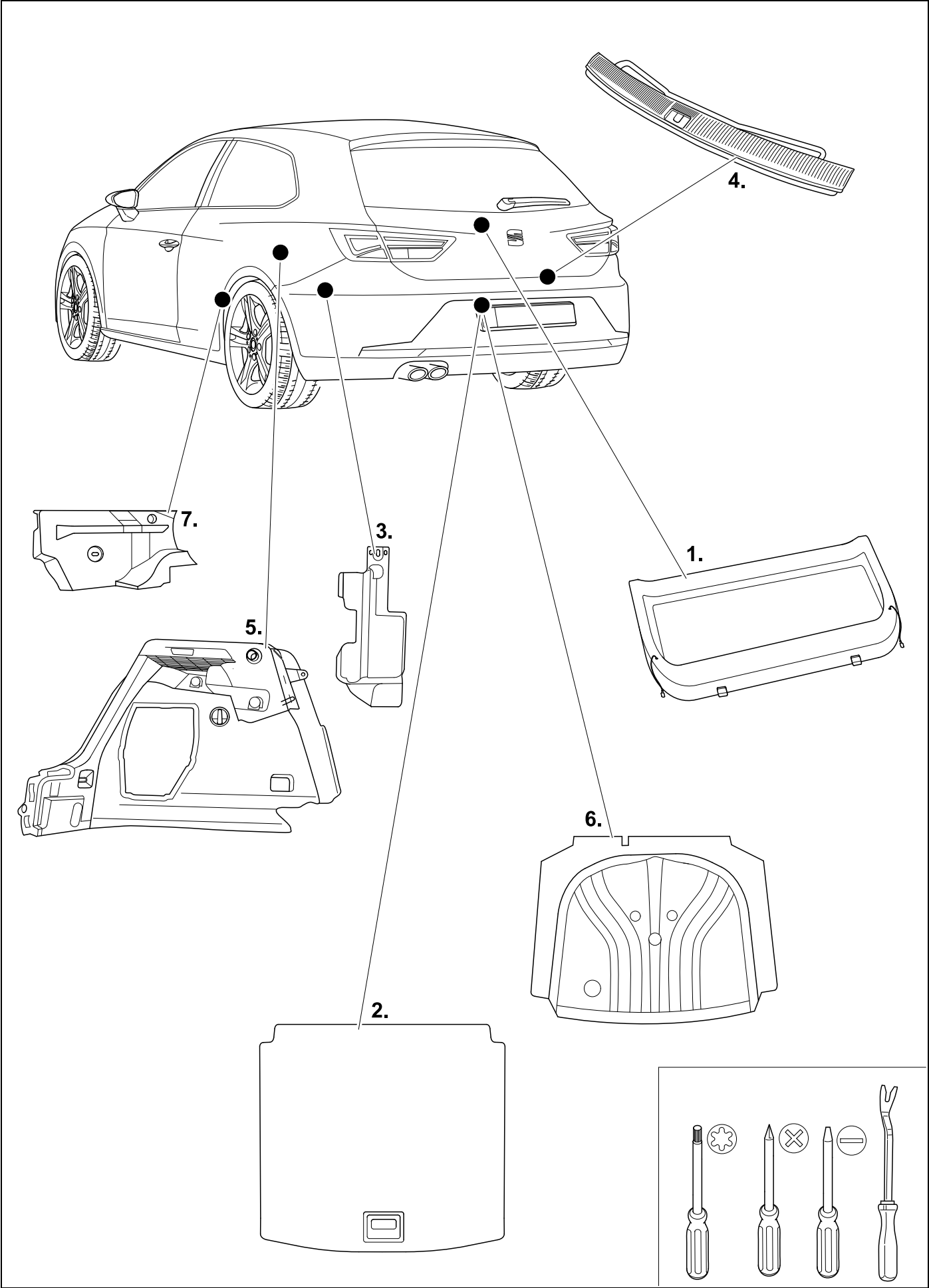

3 REMOVE

Leon PR: 1D0

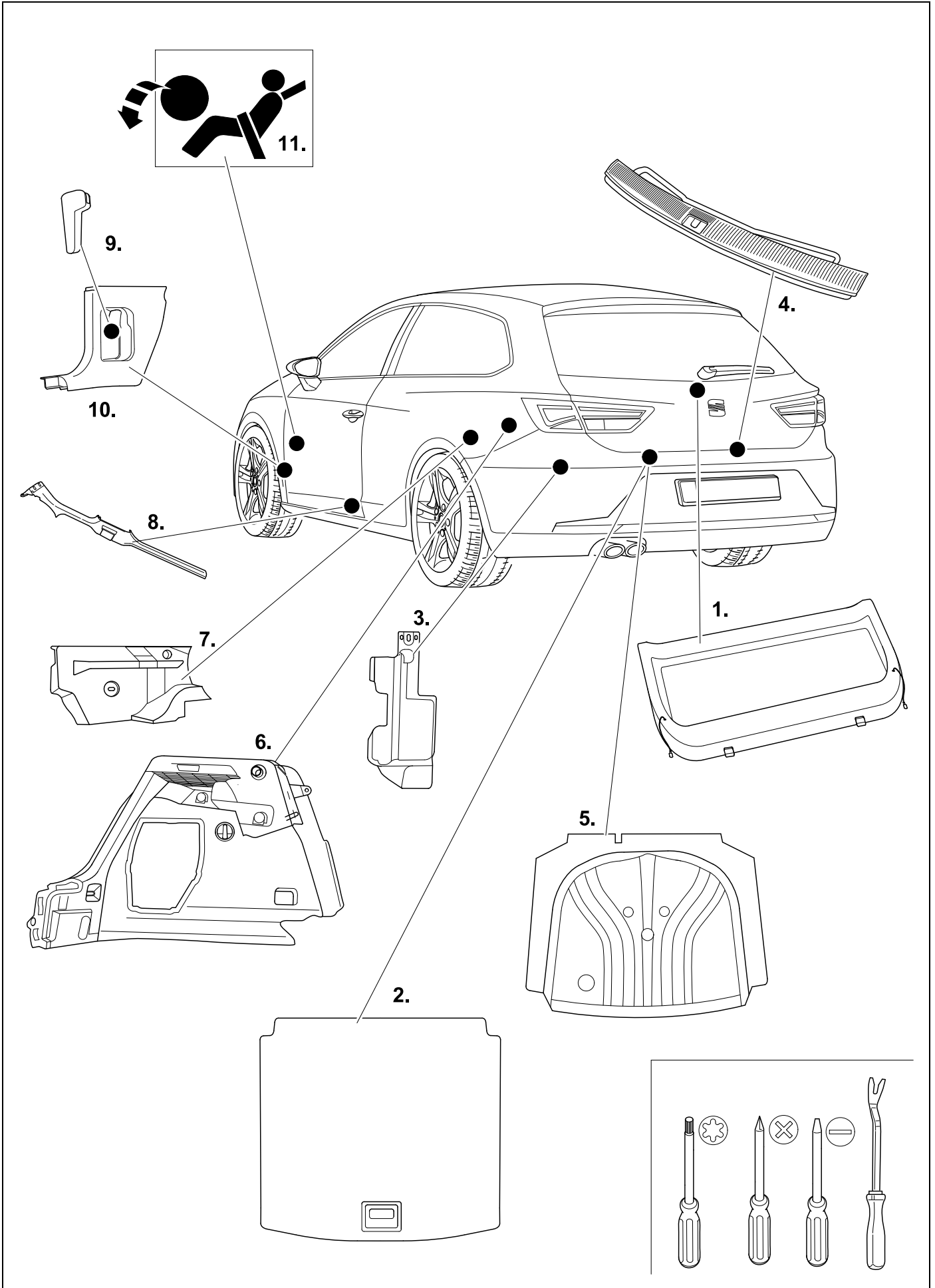

4 REMOVE

Leon ST / X-Perience PR: 1D8 / 1M5

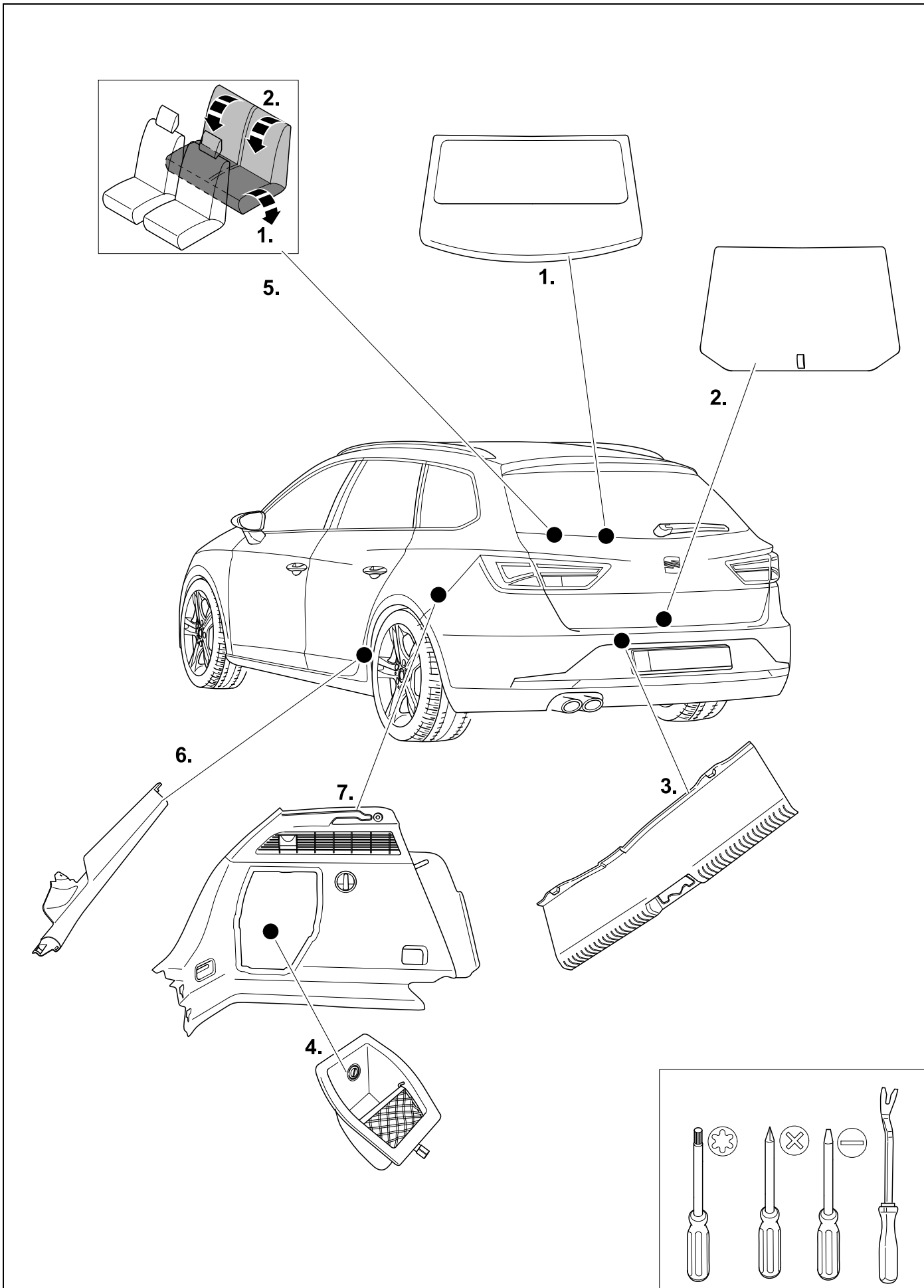

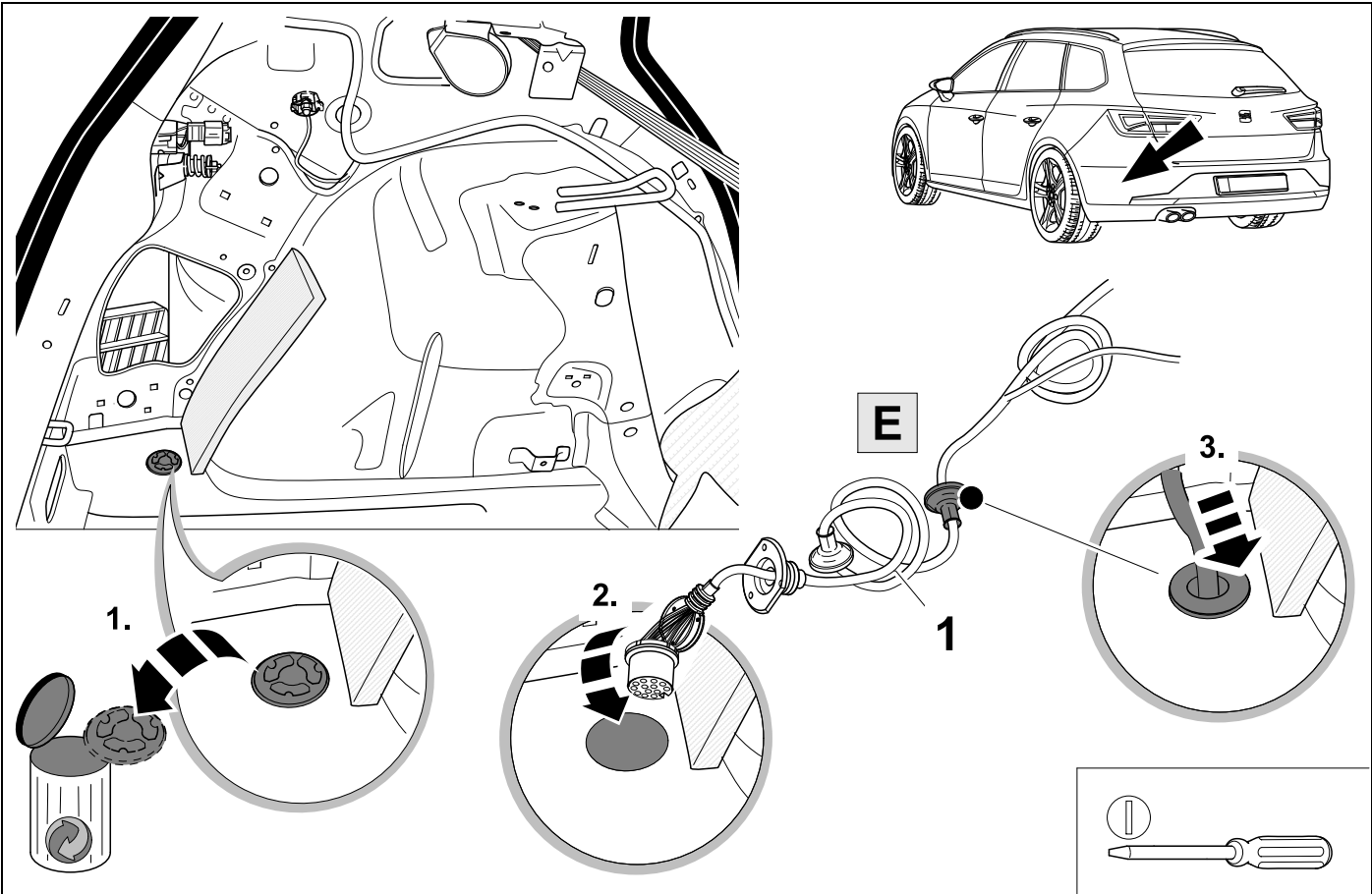

7



9

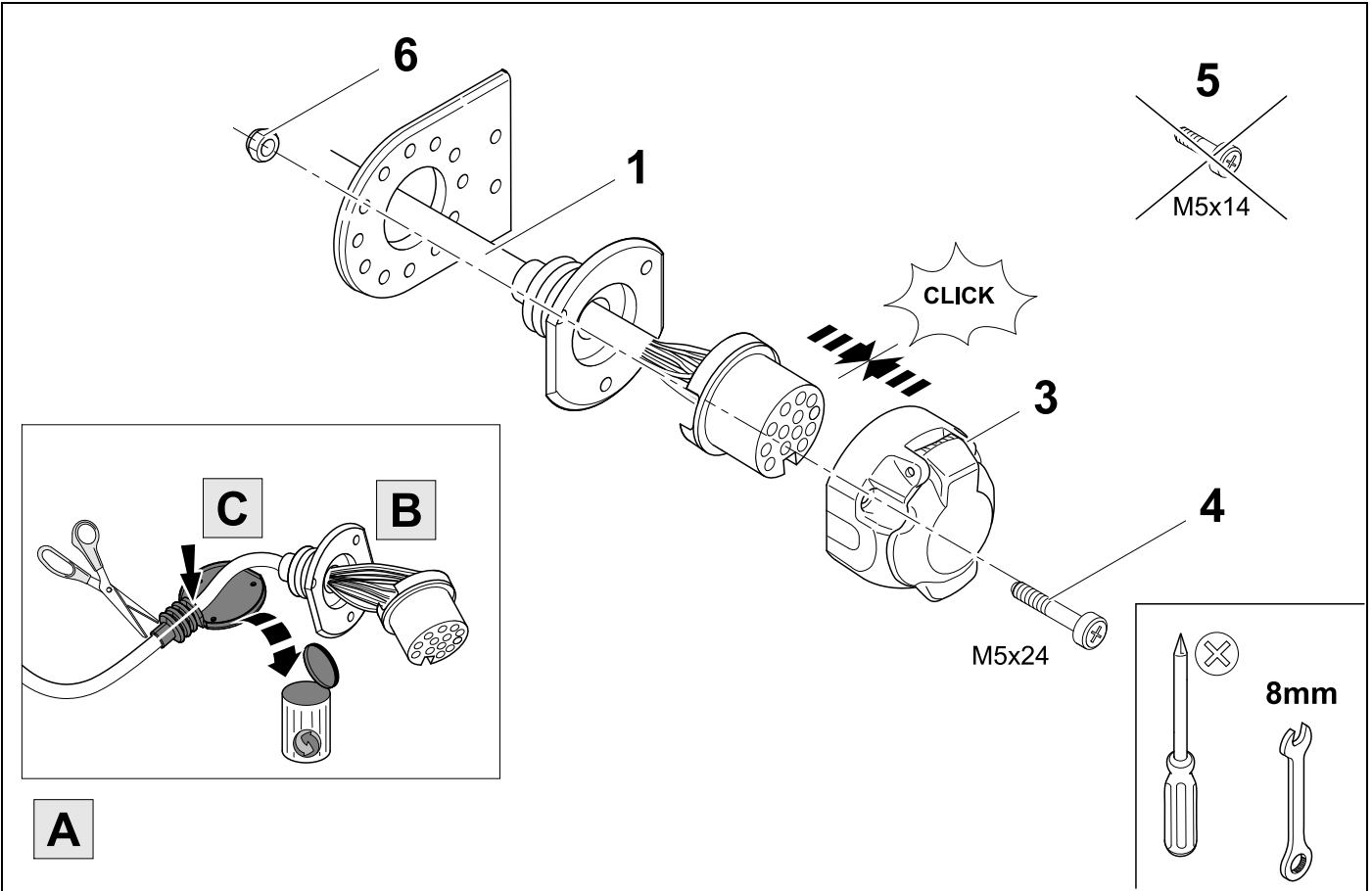

8



9

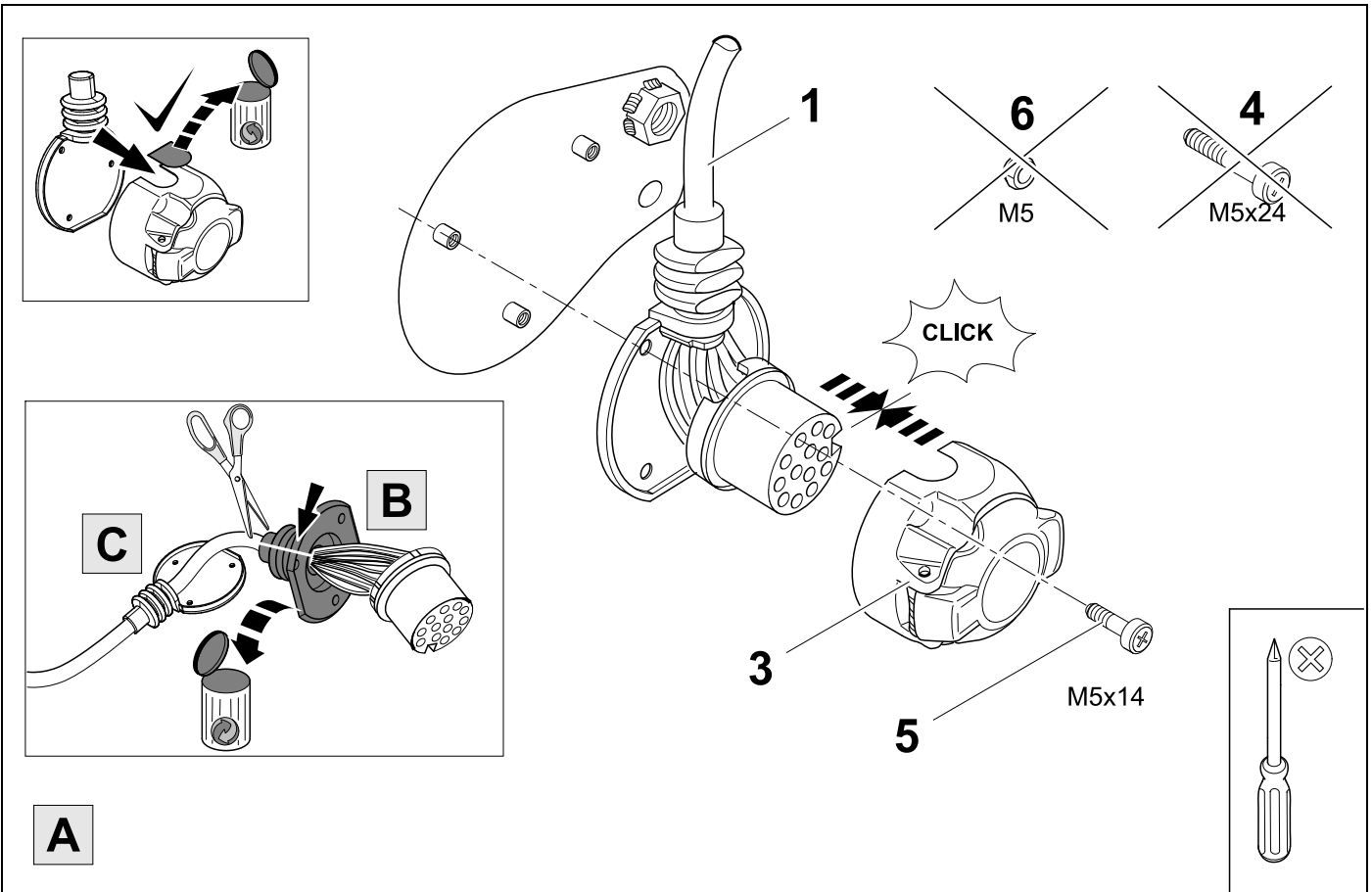



13 PIN

1	bk/wh		8	bu/rd	
2	gy		9	rd	
3	wh/bn		10	ye	
4	bk/gn		11	bn/gn	
5	gy/rd		12	no	-/-
6	bk/rd		13	bn	
7	gy/bk				

10	bk	wh	gy	gn	rd	bu	ye	bn	pu	or	no
(D)	schwarz	weiß	grau	grün	rot	blau	gelb	braun	violett	orange	nicht belegt
(GB)	black	white	grey	green	red	blue	yellow	brown	purple	orange	not occupied
(F)	noir	blanc	gris	vert	rouge	bleu	jaune	brun	violet	orange	inutilisé
(NL)	zwart	wit	grijs	groen	rood	blauw	geel	bruin	violet	oranje	niet aangesloten
(DK)	sort	hvid	grå	grøn	rød	blå	gul	brun	violet	orange	ikke anvendt
(N)	svart	hvit	grå	grønn	rød	blå	gul	brun	fiolett	oransje	ikke i bruk
(S)	svart	vit	grå	grön	röd	blå	gul	brun	violett	orange	ej använd
(FIN)	musta	valkoinen	harmaa	vihreä	punainen	sininen	keltainen	ruskea	violetti	oranssi	ei varattu
(I)	nero	bianco	grigio	verde	rosso	blu	giallo	marrone	viola	arancione	libero
(E)	negro	blanco	gris	verde	rojo	azul	amarillo	marrón	violeta	anaranja-do	no ocupado
(P)	preto	branco	cinzento	verde	vermelho	azul	amarelo	castanho	violeta	laranja	não ocupado
(GR)	μαύρος	λευκός	Γκρι	πράσινος	κόκκινος	μπλε	κίτρινος	καφέ	Μωβ	πορτοκαλί	δεν είναι κατ'επιτημένως
(PL)	czarny	biały	szary	zielony	czerwony	niebiesko	żółty	brazowy	fioletowy	pomarańczowy	wolny
(CZ)	černý	bílý	šedý	zelený	červený	modrý	žlutý	hnědý	fialový	oranžový	neobsazen
(TR)	siyah	beyaz	gri	yeşil	kırmızı	mavi	sarı	kahverengi	mor	portakal rengi	boş
(H)	fekete	fehér	szürke	zöld	piros	kék	sárga	barna	ibolyakék	narancssárga	nem foglalt
(HR)	crno	bijelo	sivo	zeleno	crveno	plavo	zuto	smeđe	ljubičasto	narandasto	nije zauzeto
(BUL)	черен	бял	сив	зелен	червен	син	жълт	кафяв	виолетов	оранжев	свободно
(RO)	negru	alb	gri	verde	roșu	albastru	galben	maro	violet	portocaliu	liber
(RU)	черный	белый	серый	зеленый	красный	голубой	жёлтый	коричневый	пурпурный	оранжевый	свободно
(LT)	juoda	balta	pilka	žalia	raudona	mėlyna	geltona	ruda	purpurinė	oranžinė	laisva
(LV)	melna	balta	pelēka	zaļa	sarkana	zila	dzeltena	brūna	purpur-sarkana	oranža	brīvs
(EST)	must	valge	hall	roheline	punane	sinine	kollane	pruun	purpur-punane	oraanz	vaba
(SLO)	črna	bela	siva	zelena	rdeča	modra	rumena	smeđ	vijoličast	oranžen	ni zasedeno
(SK)	čierny	biely	šedý	zelený	červený	modrý	žltý	hnědý	fialový	pomaraňový	neobsadený

11

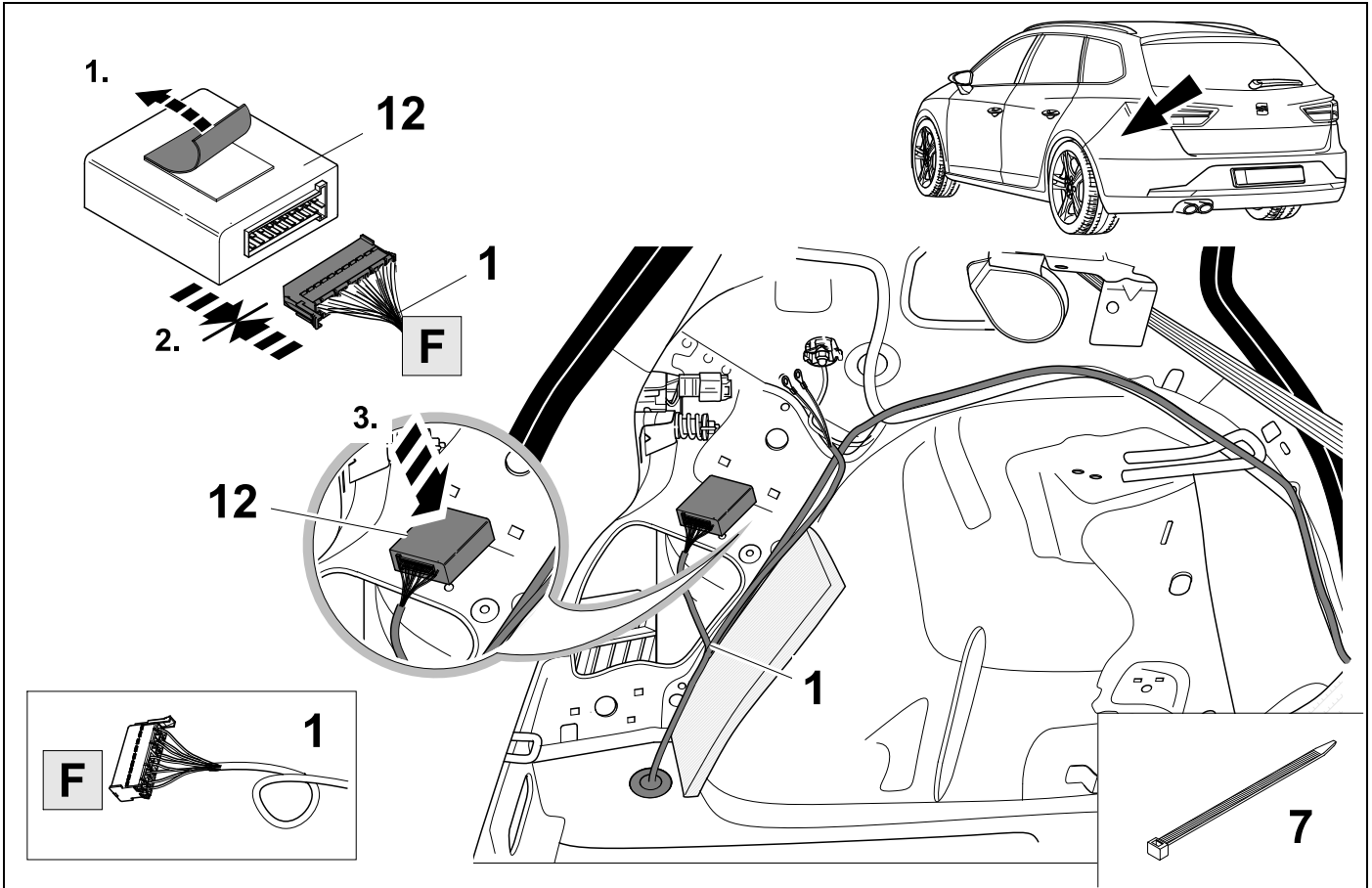

12

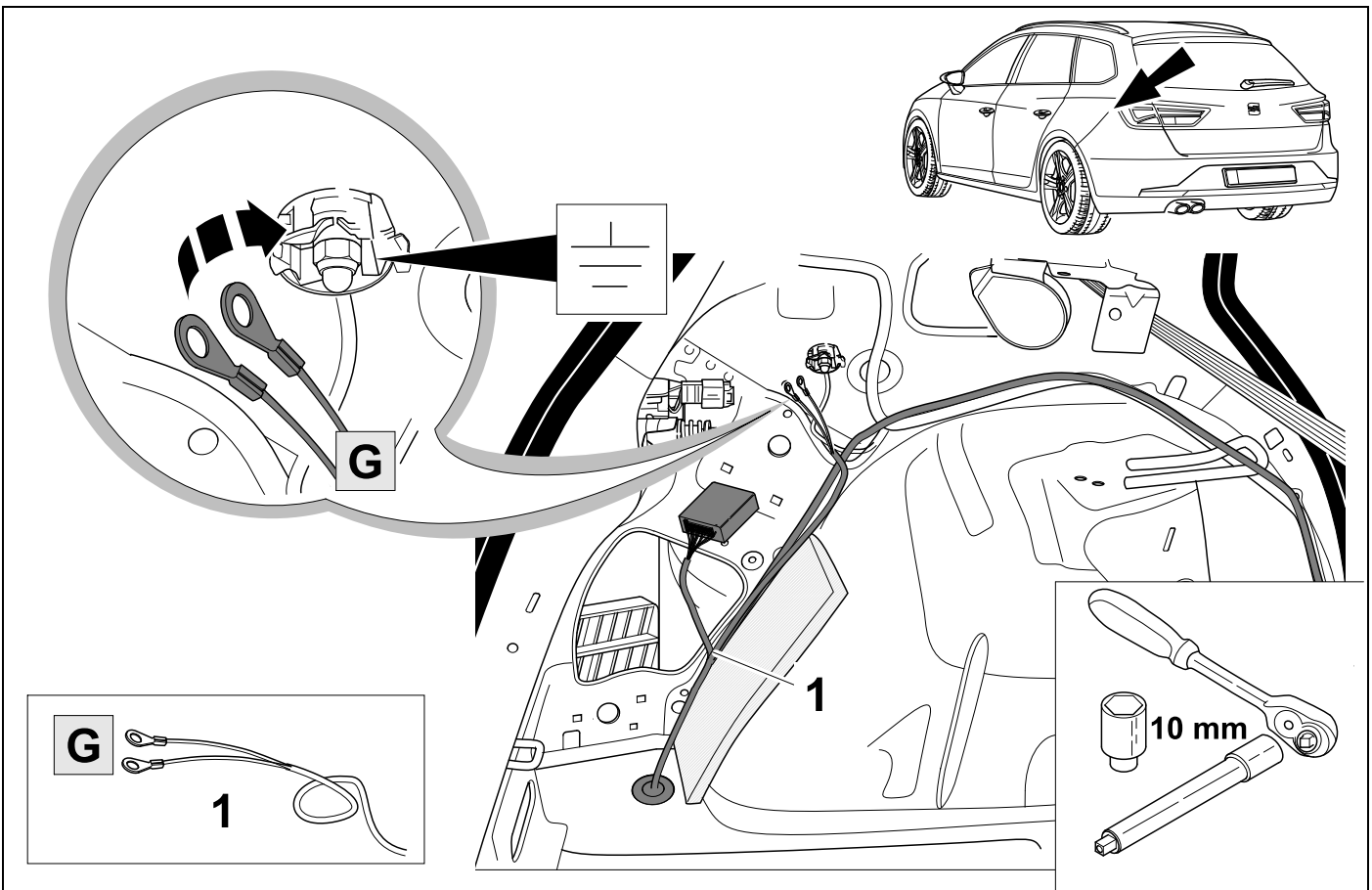

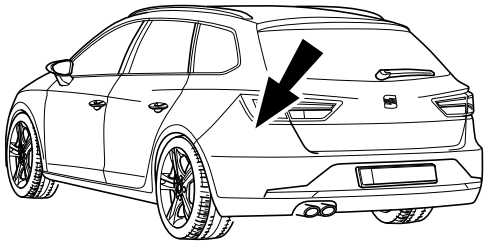

Vehicles without trailer preparation PR: 1D0

OPTION 1

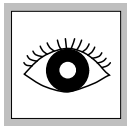
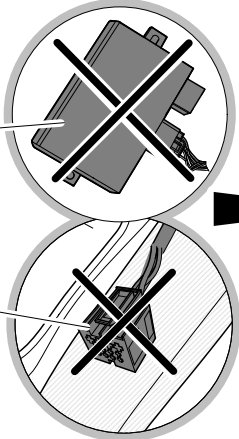
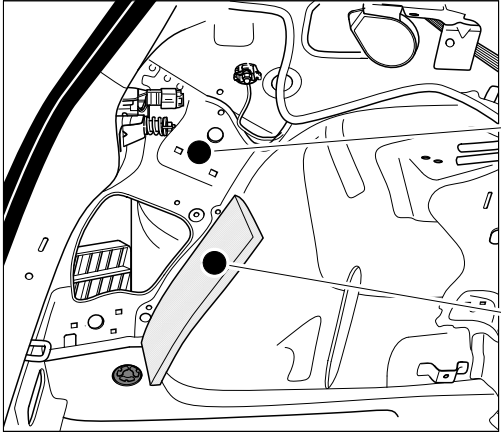

15 ⇨ 28

39 ⇨ 50

+

Vehicles with trailer preparation PR: 1D8

OPTION 2

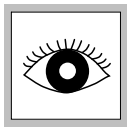
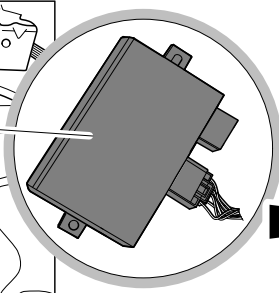
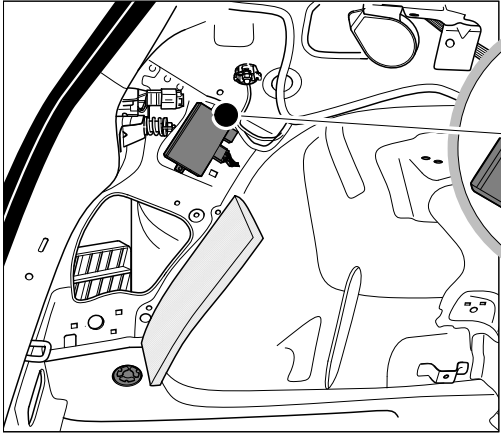

29

OPTION 3

30 ⇨ 31

39 ⇨ 50

+

+

Vehicles with trailer preparation PR: 1M5

OPTION 3

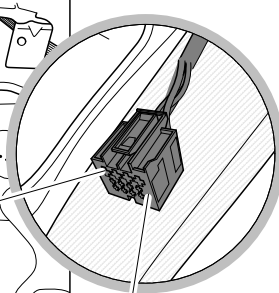
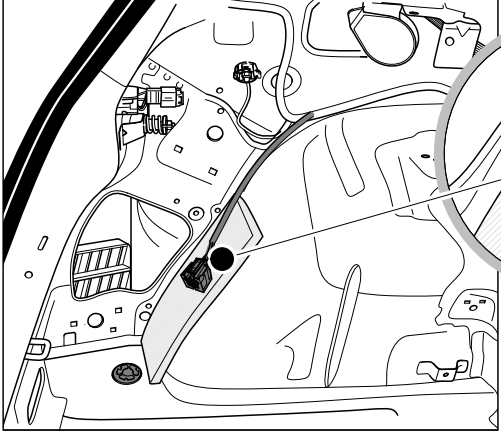

rd
12 PIN

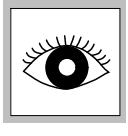

30 ⇨ 31

38 ⇨ 50

+

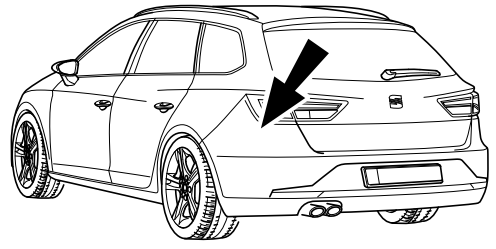

Vehicles without trailer preparation PR: 1D0

OPTION 1

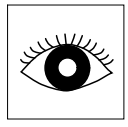
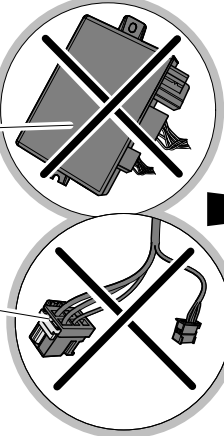
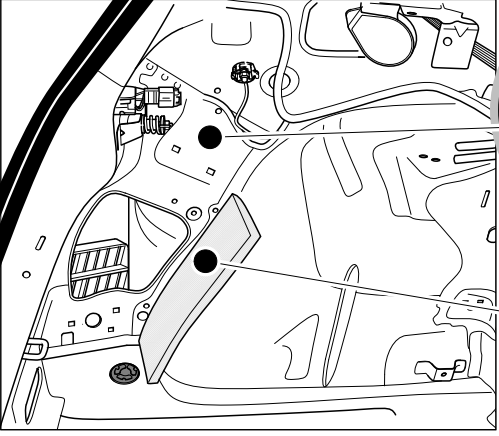

15 ⇨ 28

+
39 ⇨ 50

Vehicles with trailer preparation PR: 1D8

OPTION 4

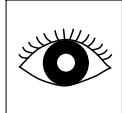
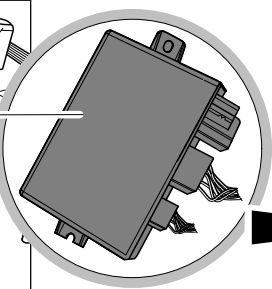
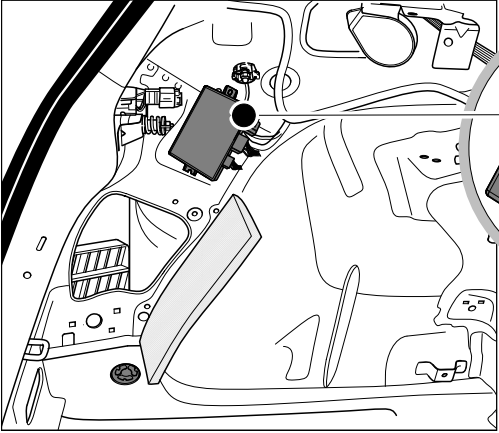

32

+
OPTION 5

33 ⇨ 37

+
39 ⇨ 50

Vehicles with trailer preparation PR: 1M5

OPTION 5

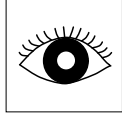
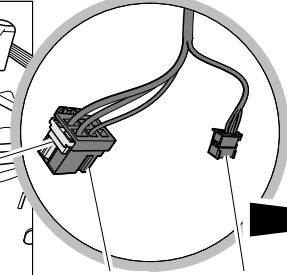
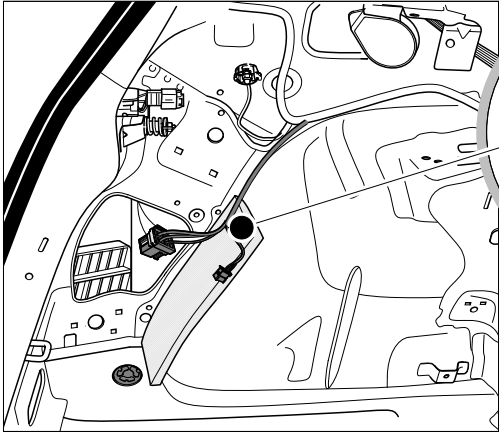

33 ⇨ 50

15

OPTION 1

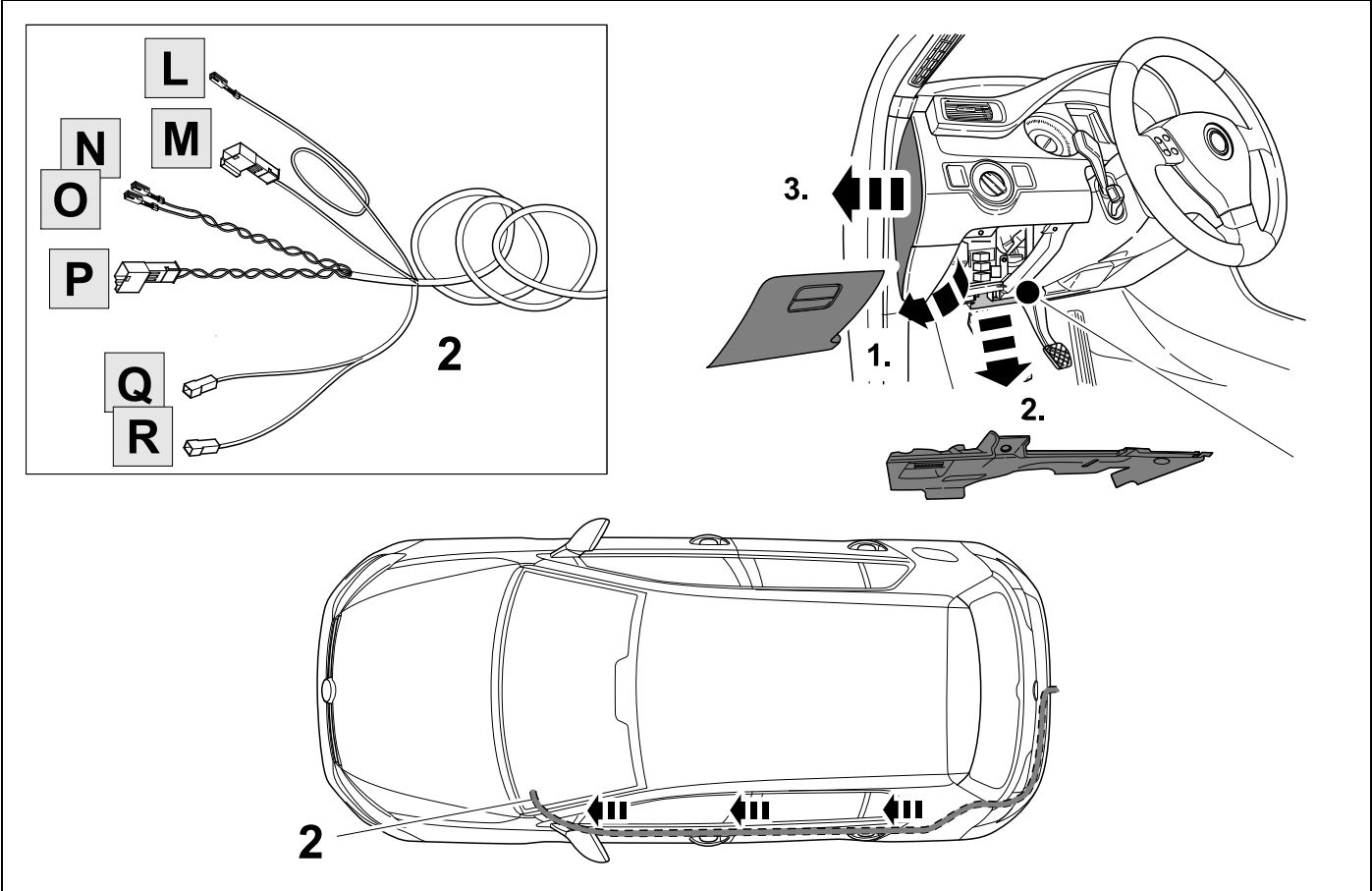

16

10 + 44

OPTION 1

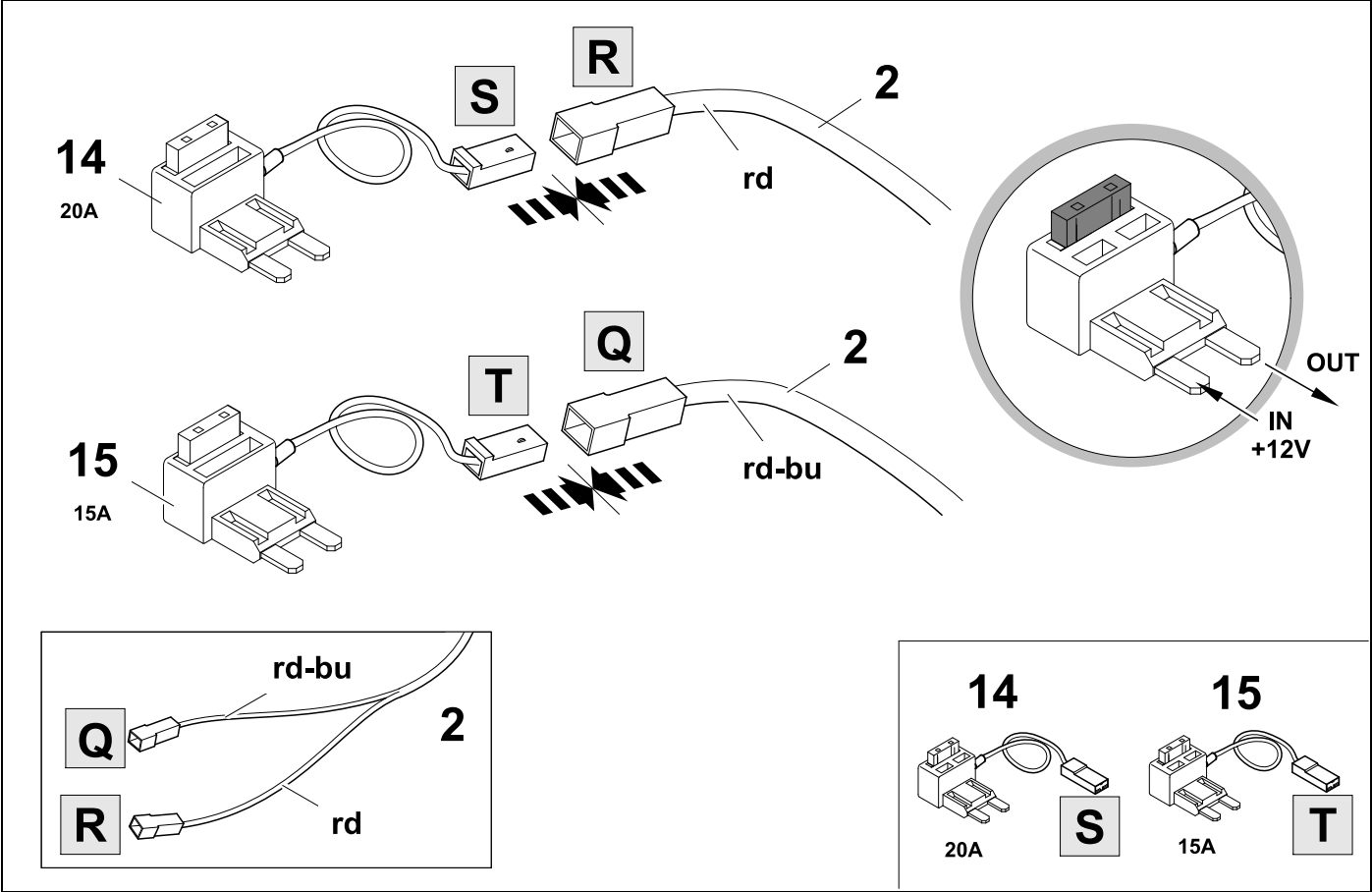

17



44

OPTION 1

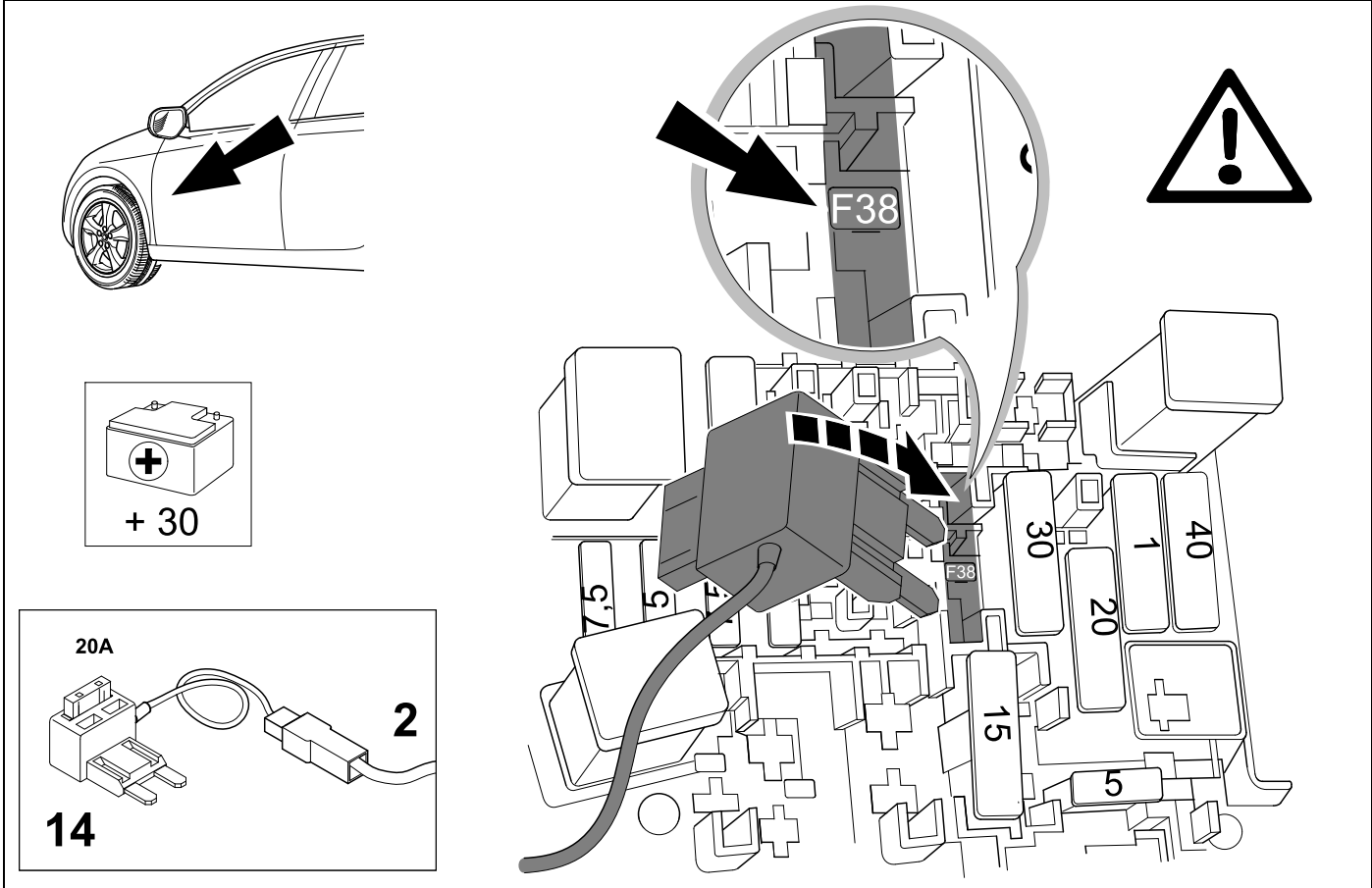

18



44

OPTION 1

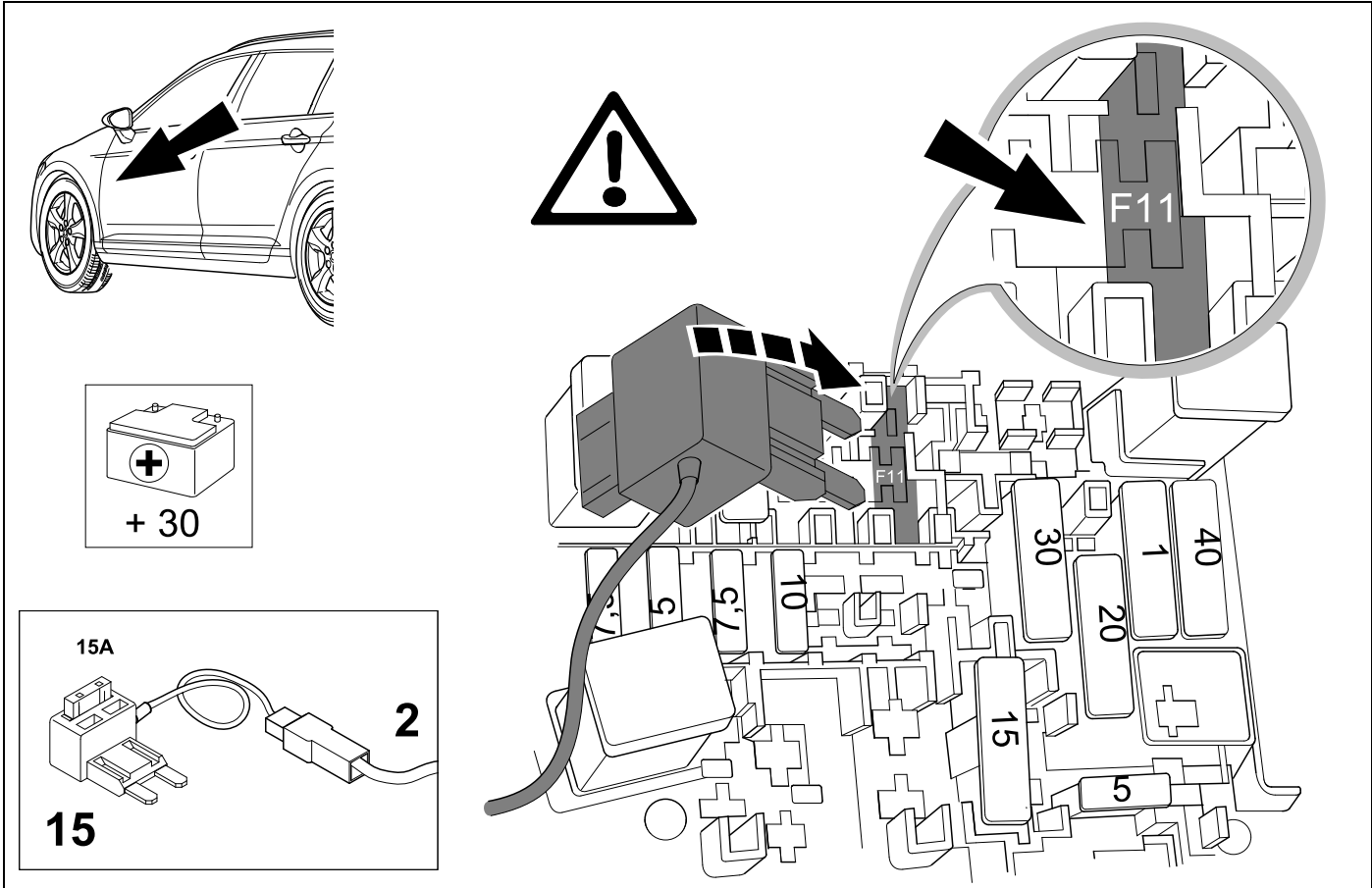

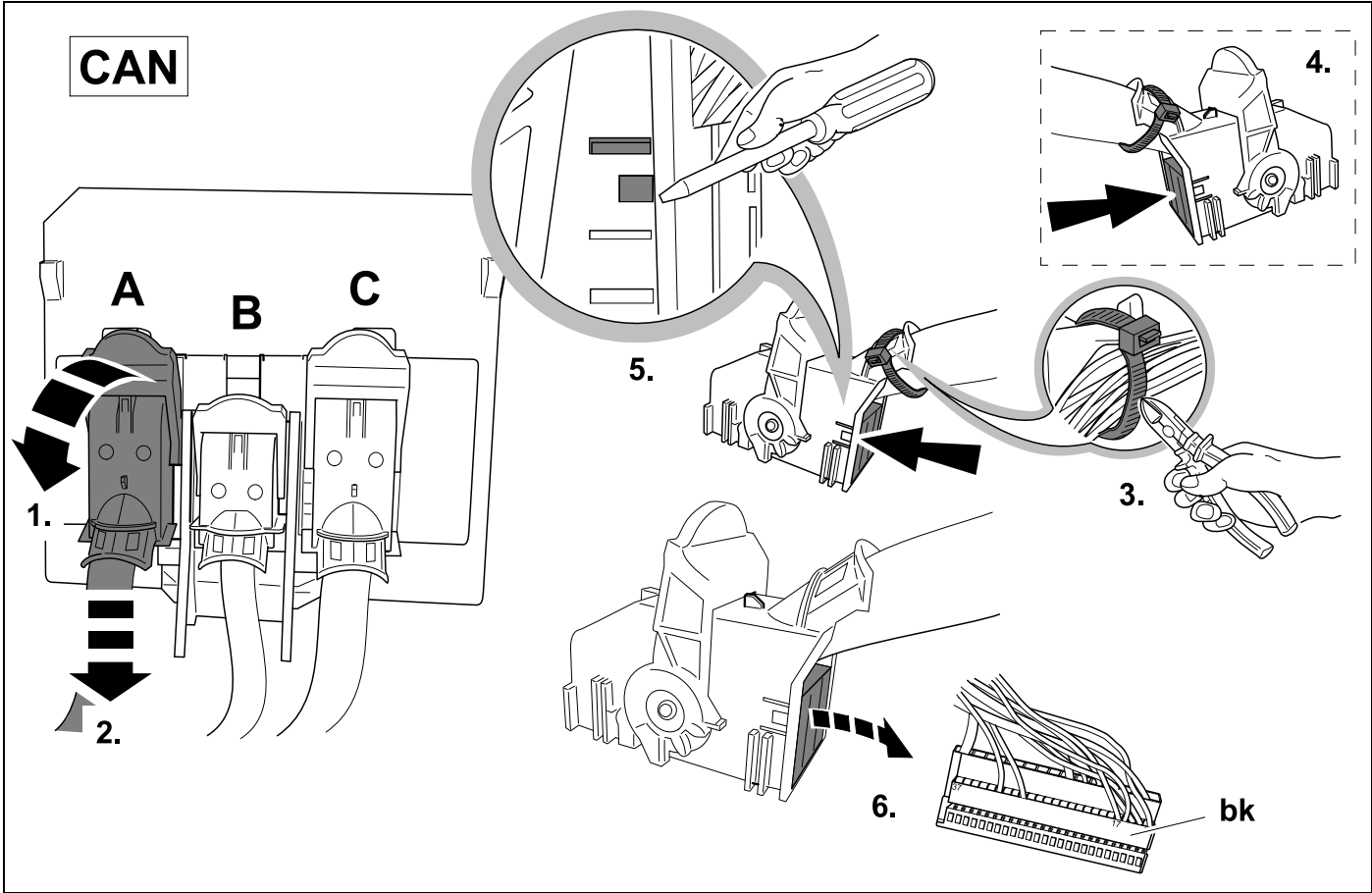
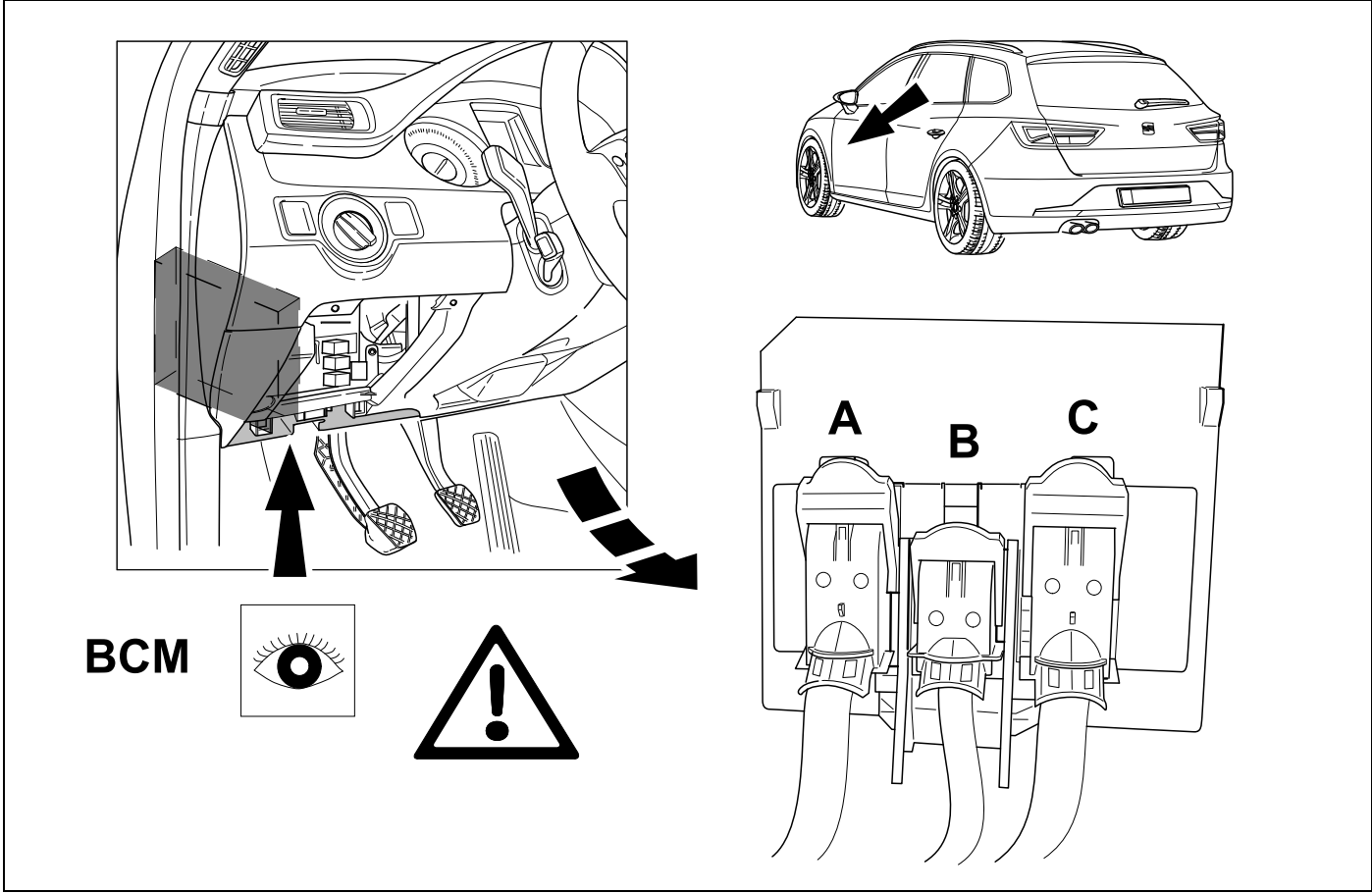

21



10

OPTION 1

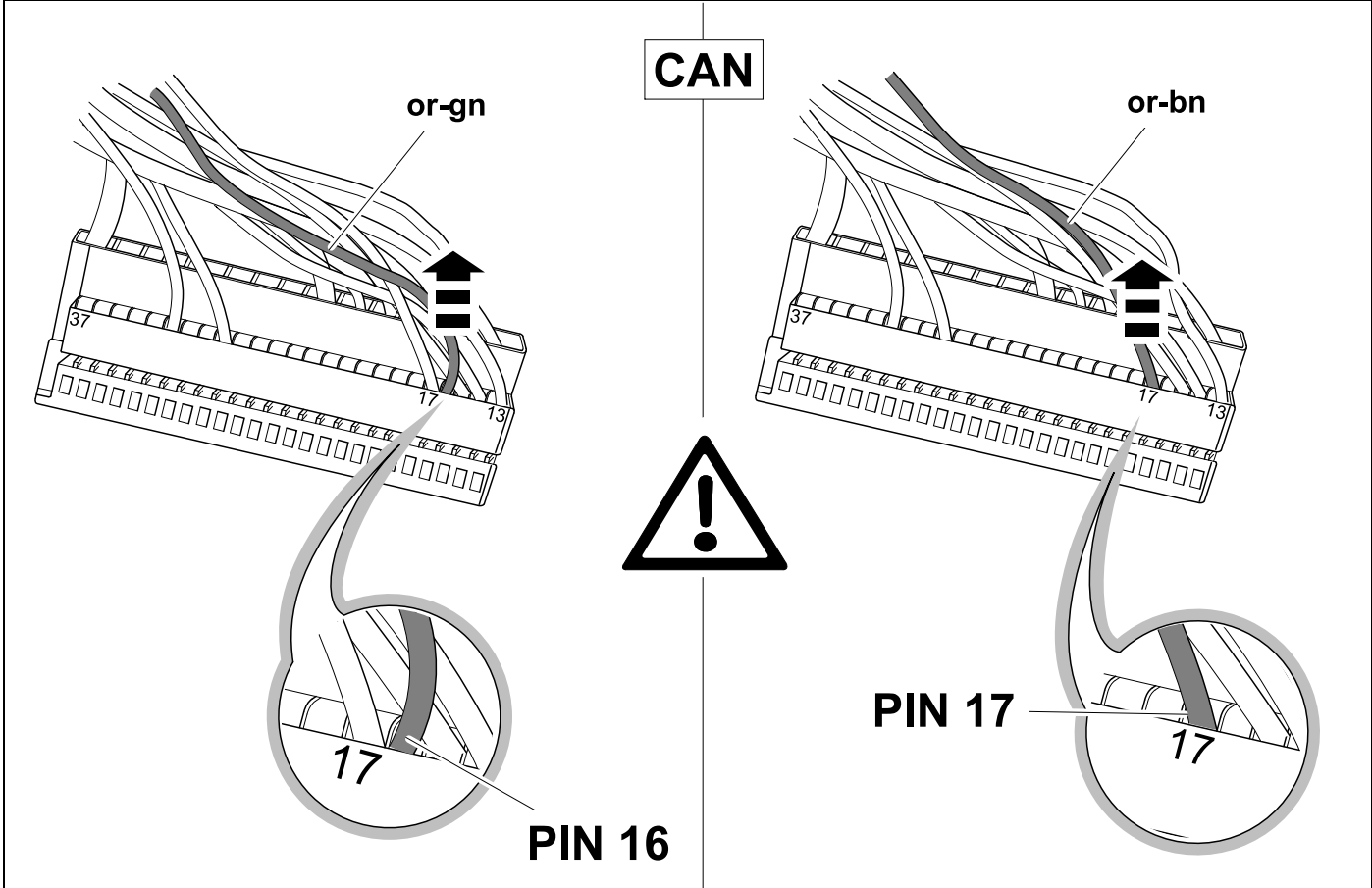

22



10

OPTION 1

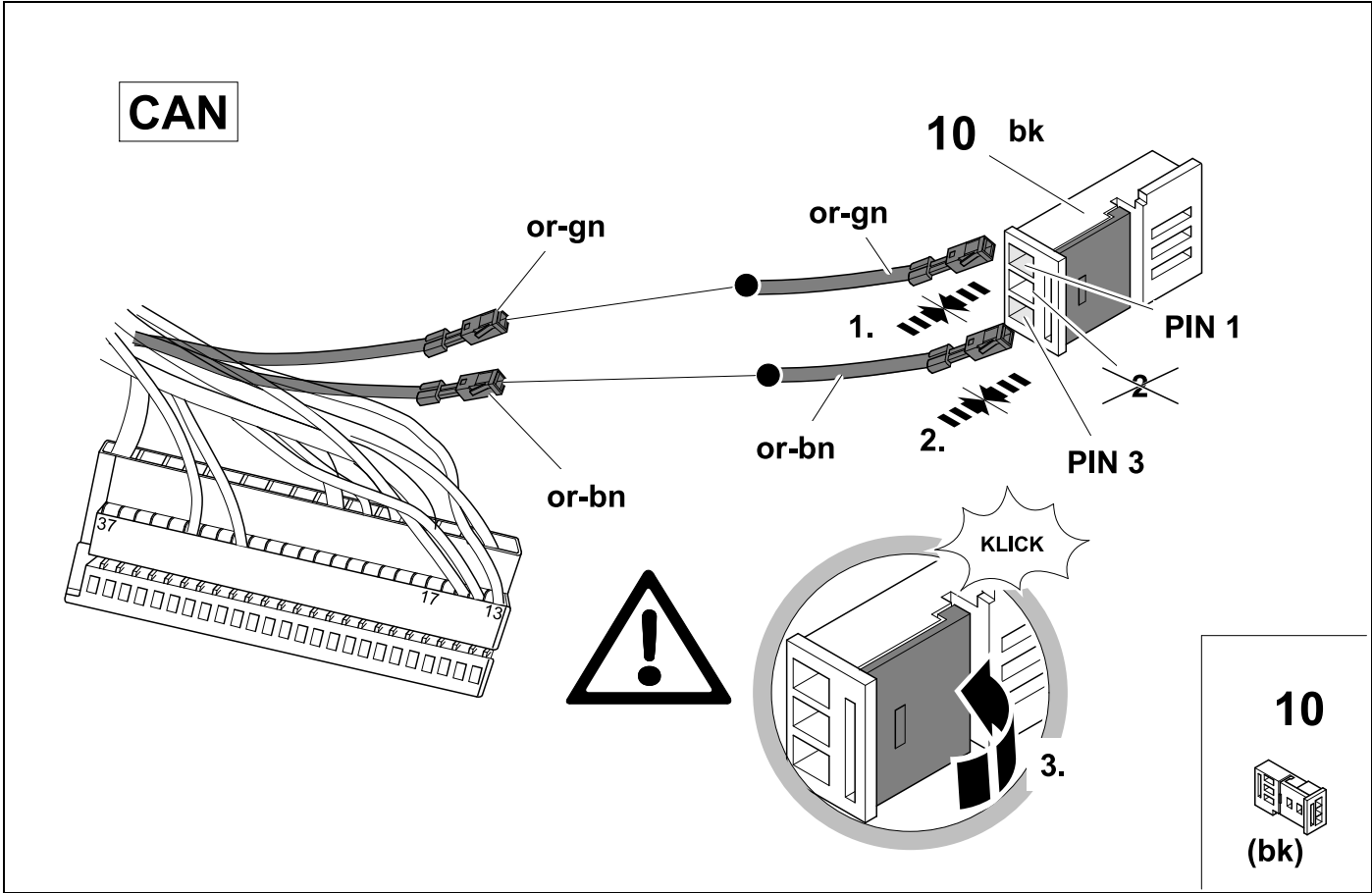

23



10

OPTION 1

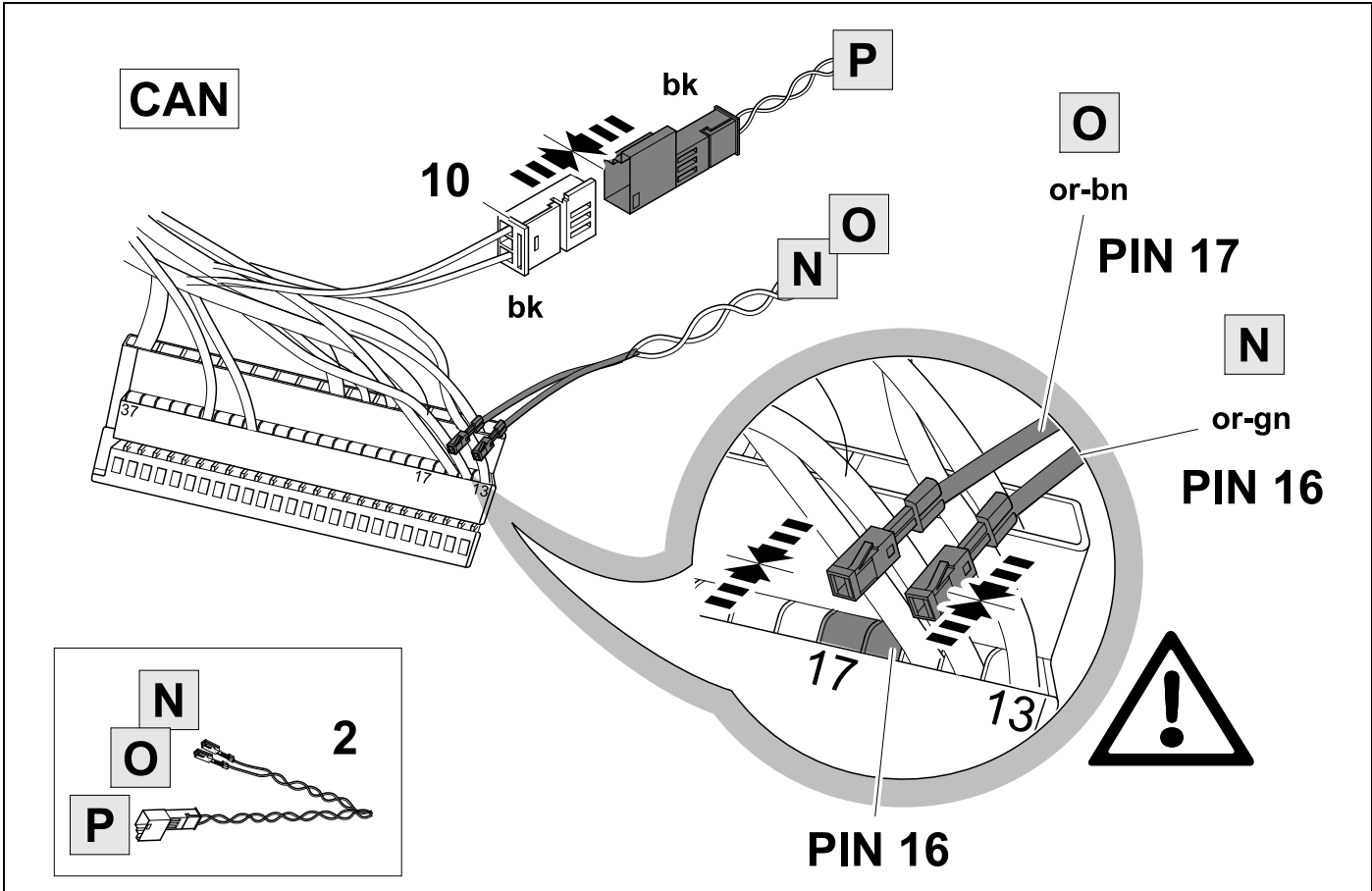

24

OPTION 1

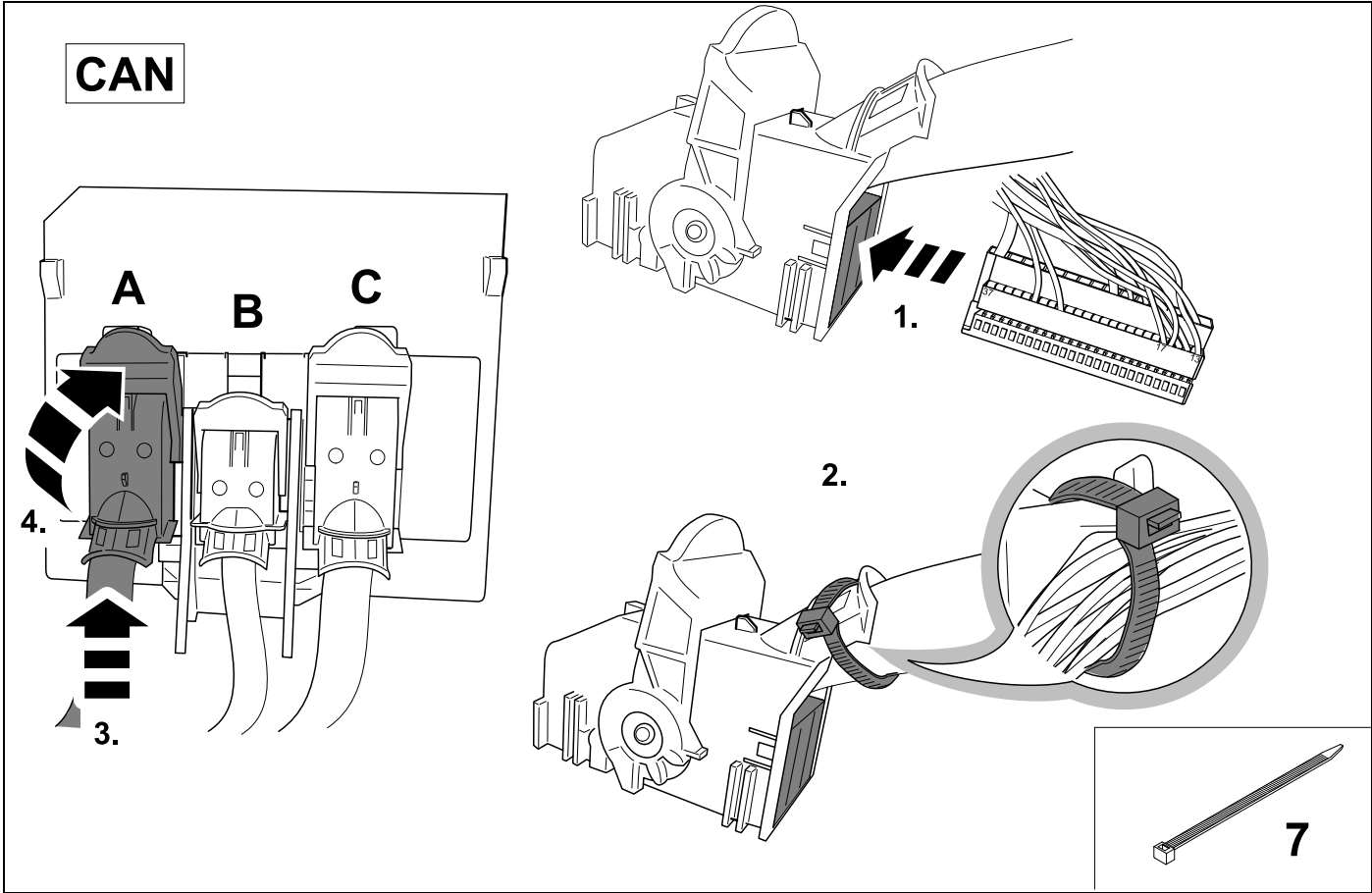

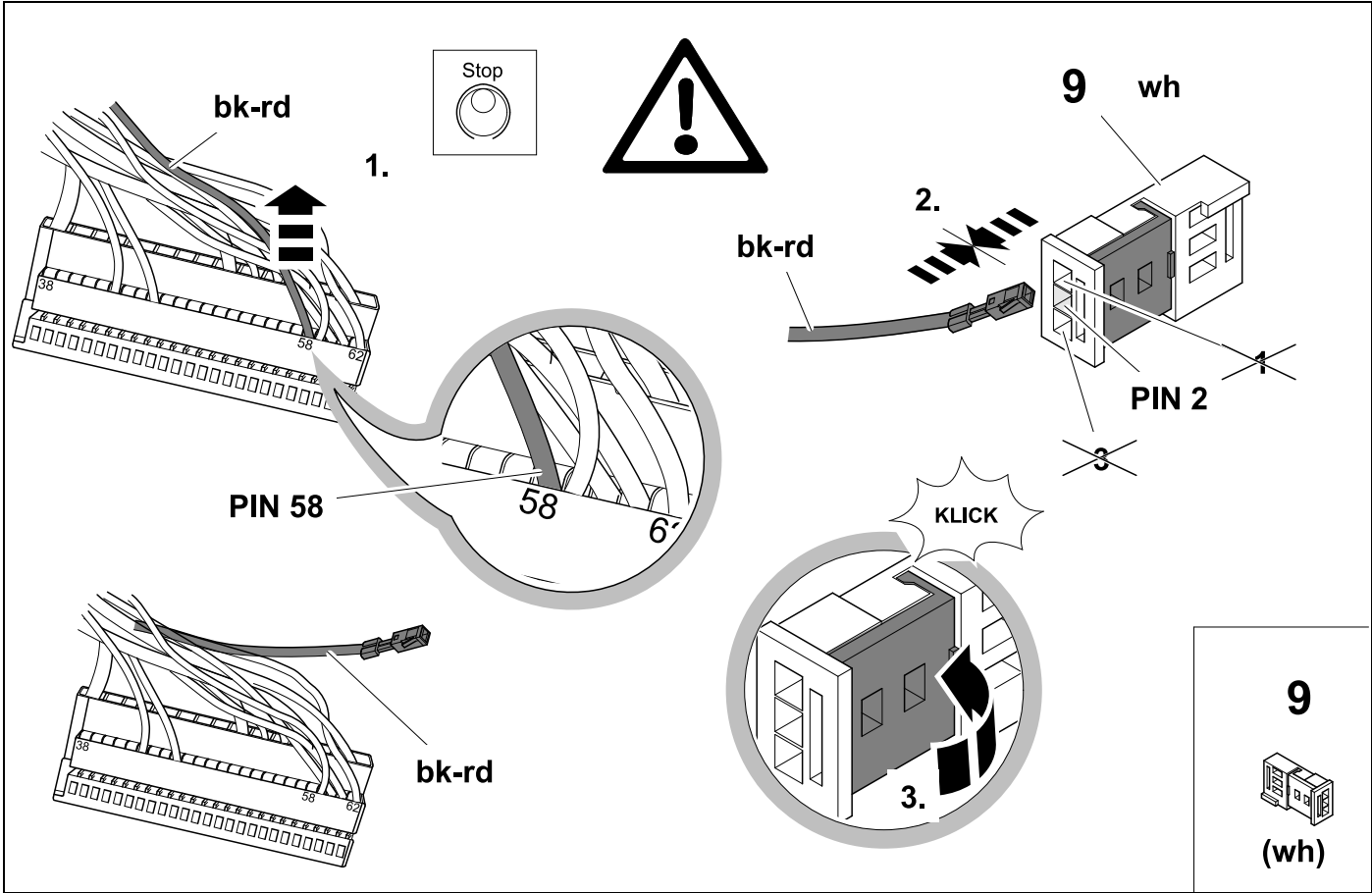
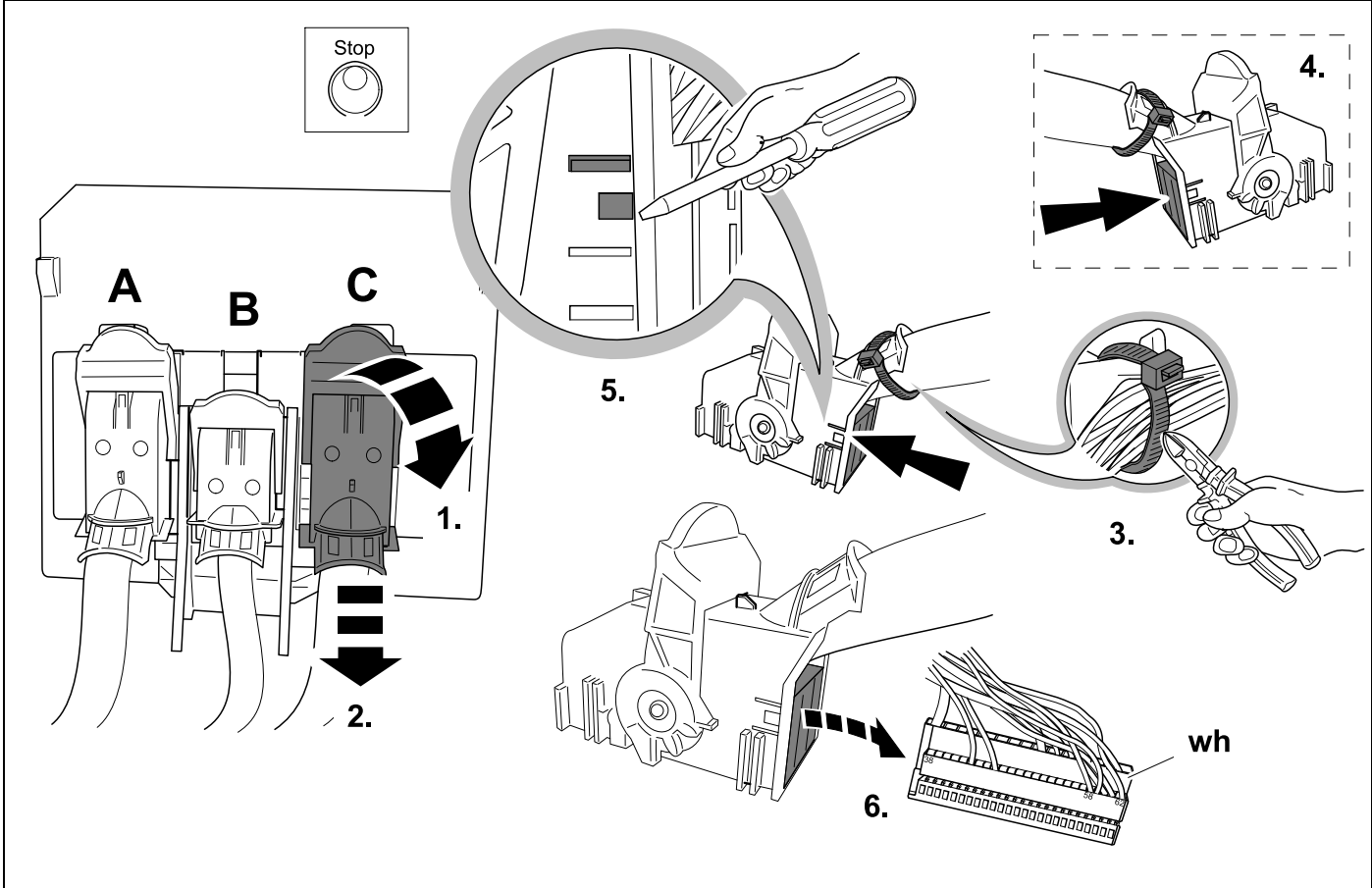

27



10

OPTION 1

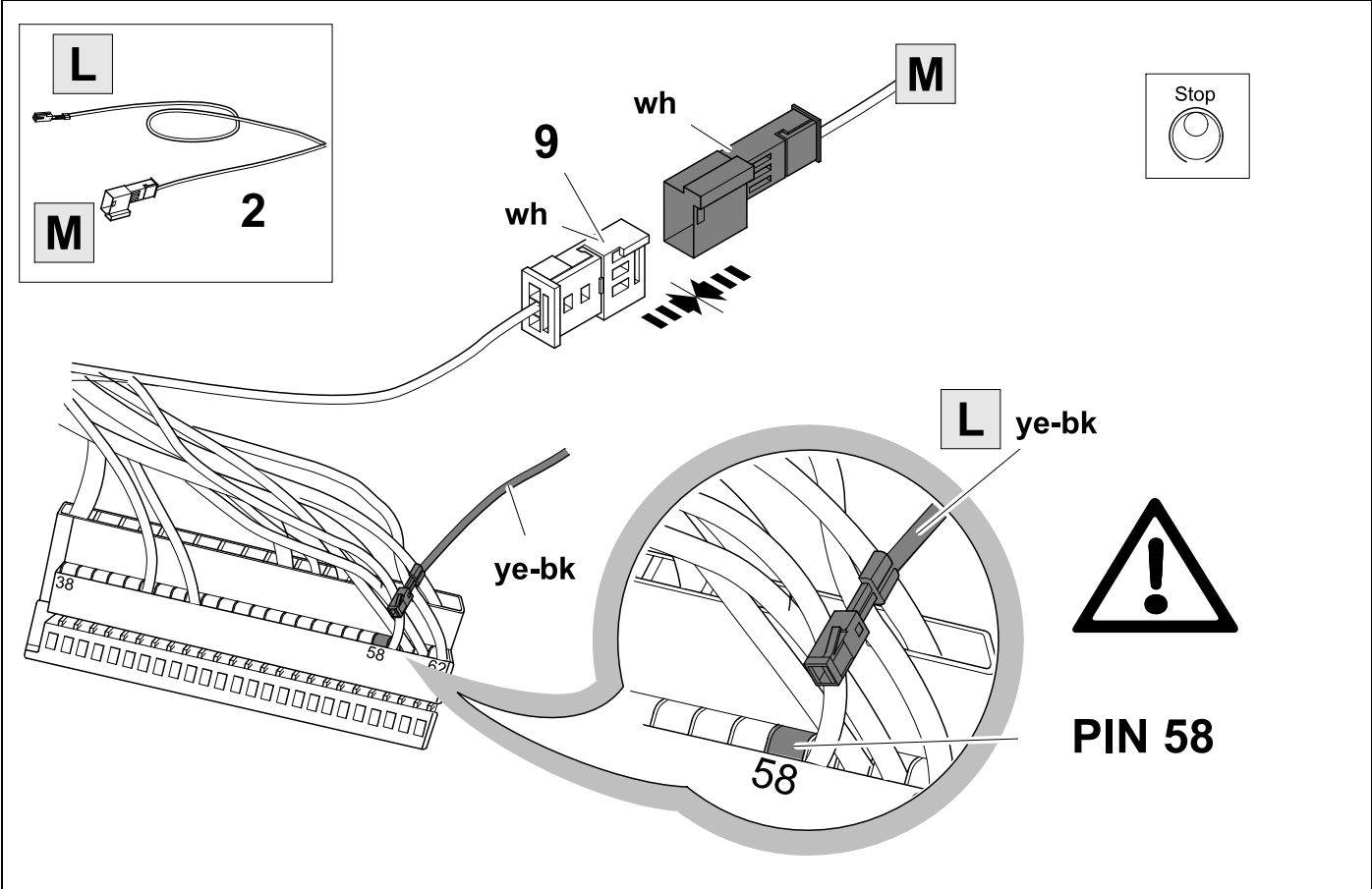

28

OPTION 1

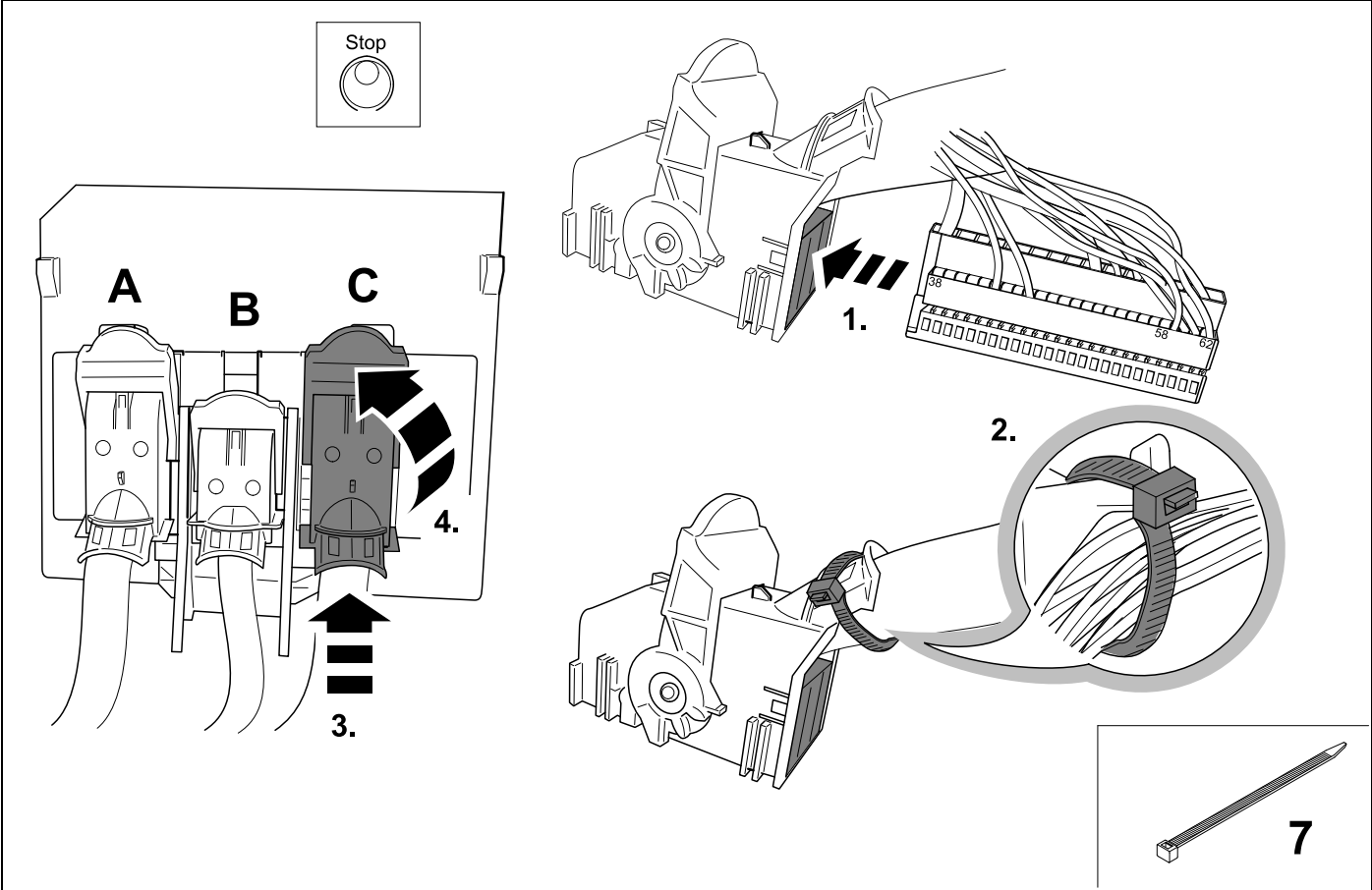

29

👁️ ⇒ 10

OPTION 2

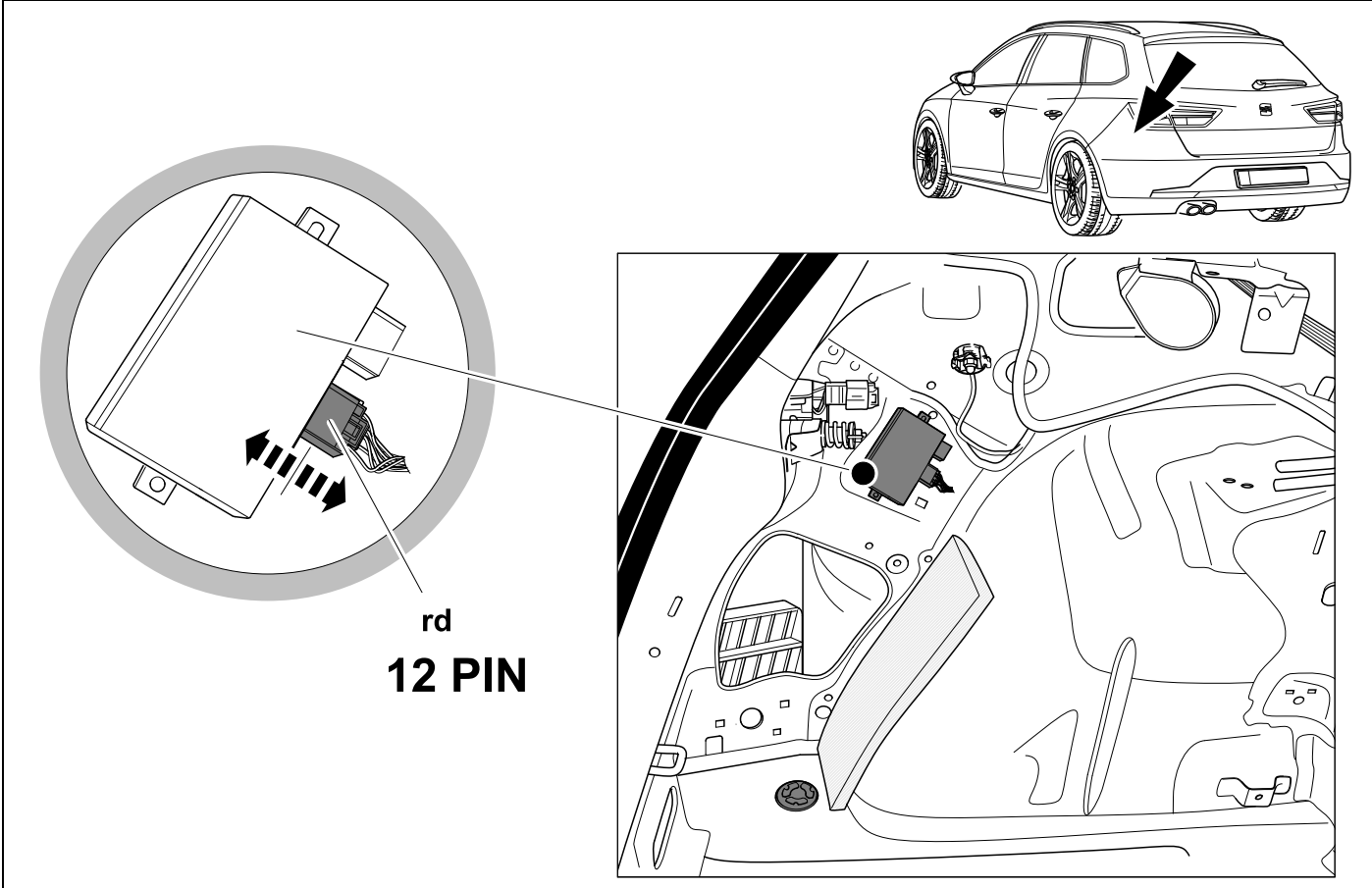

30

👁️ ⇒ 10

OPTION 3

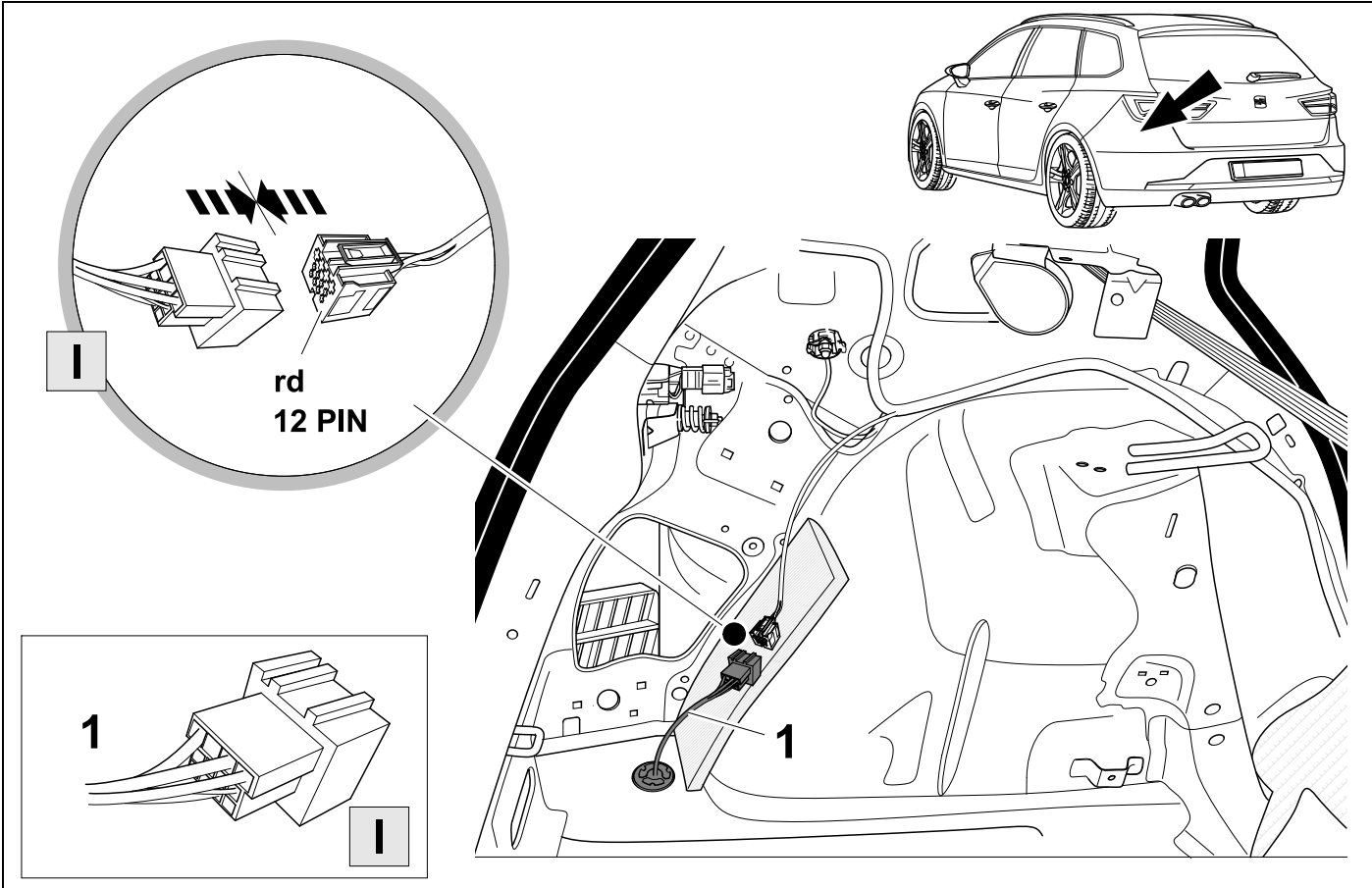

31



10

OPTION 3

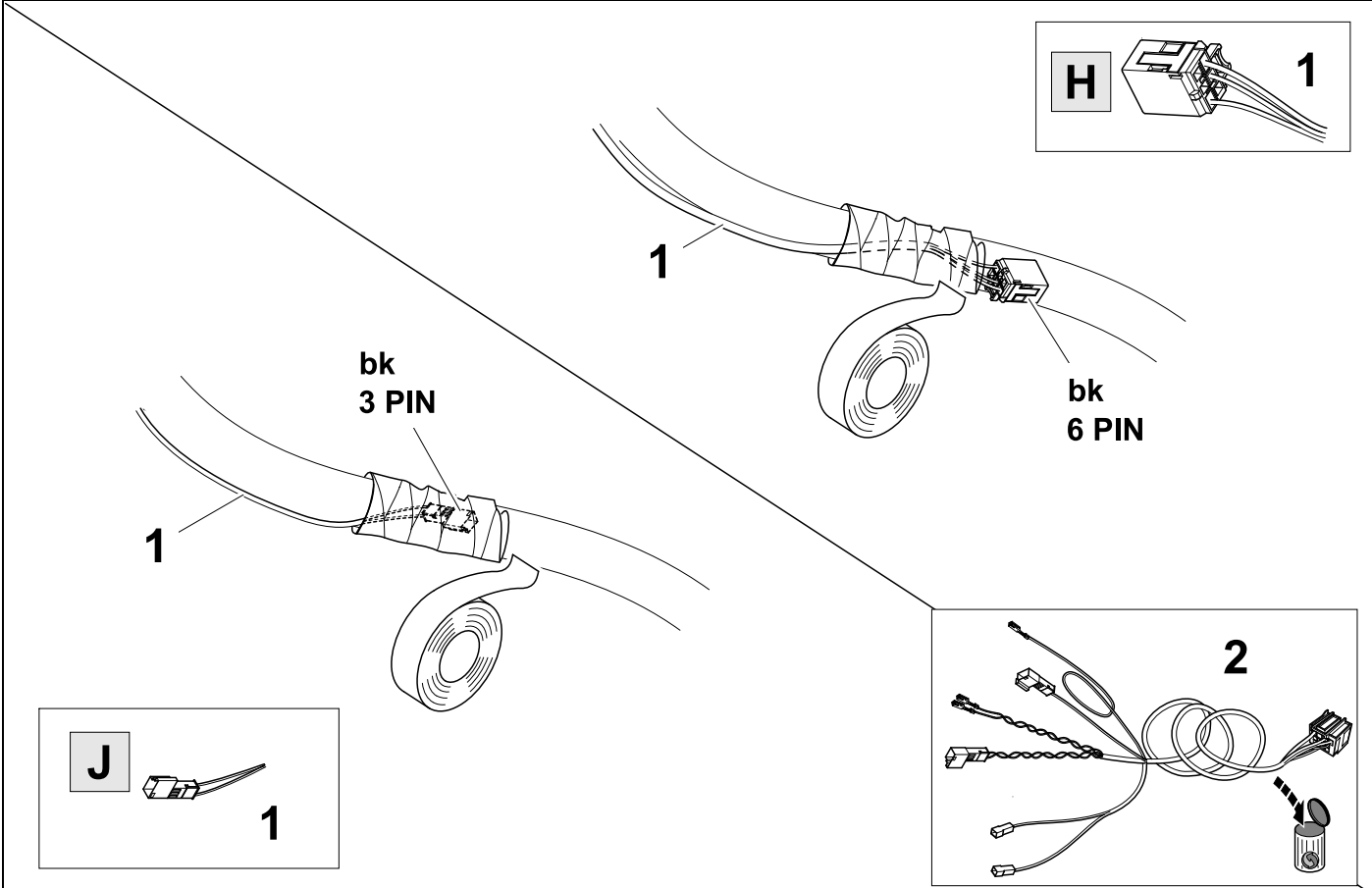

32



10

OPTION 4

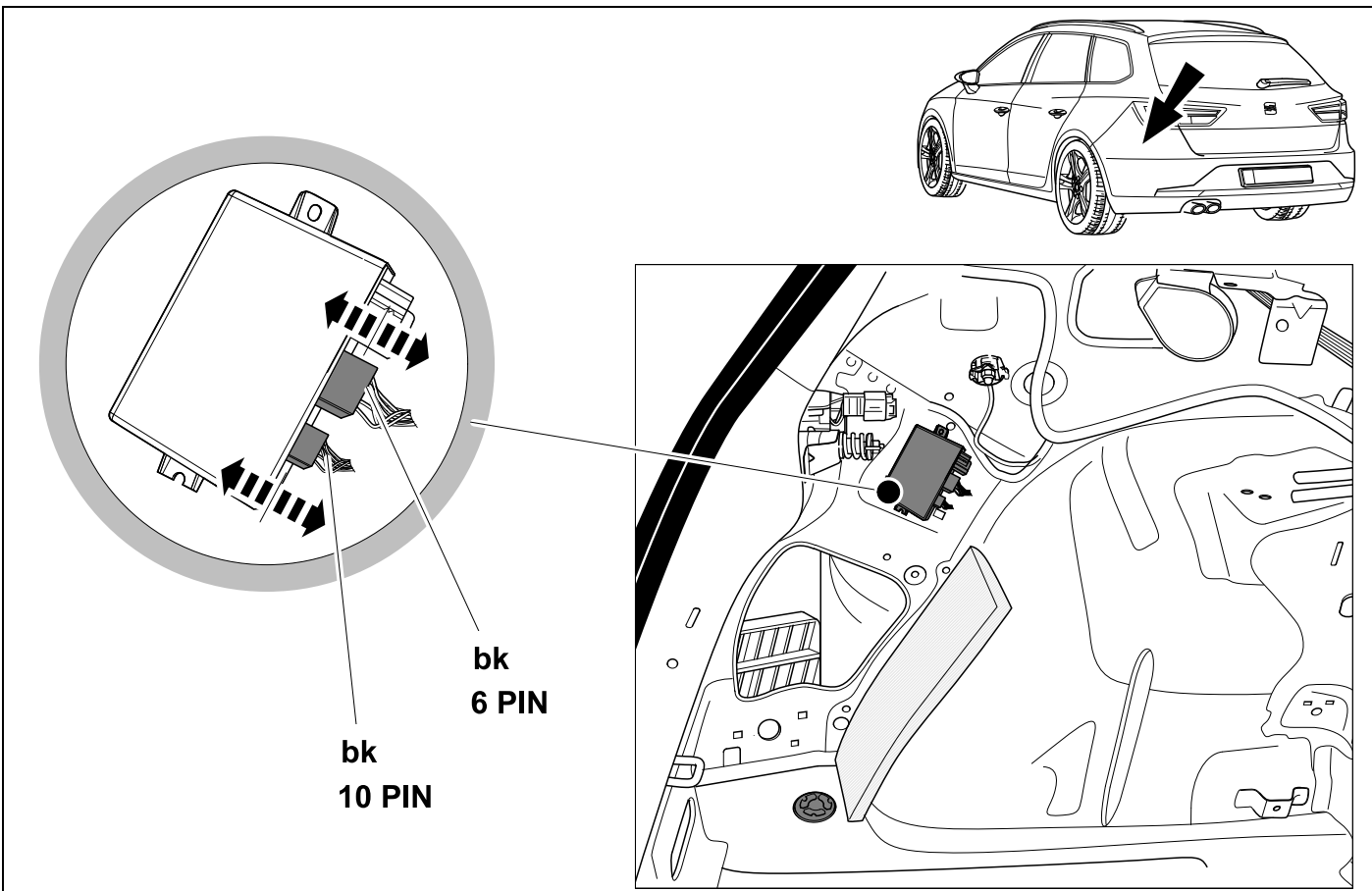

33



10

OPTION 5

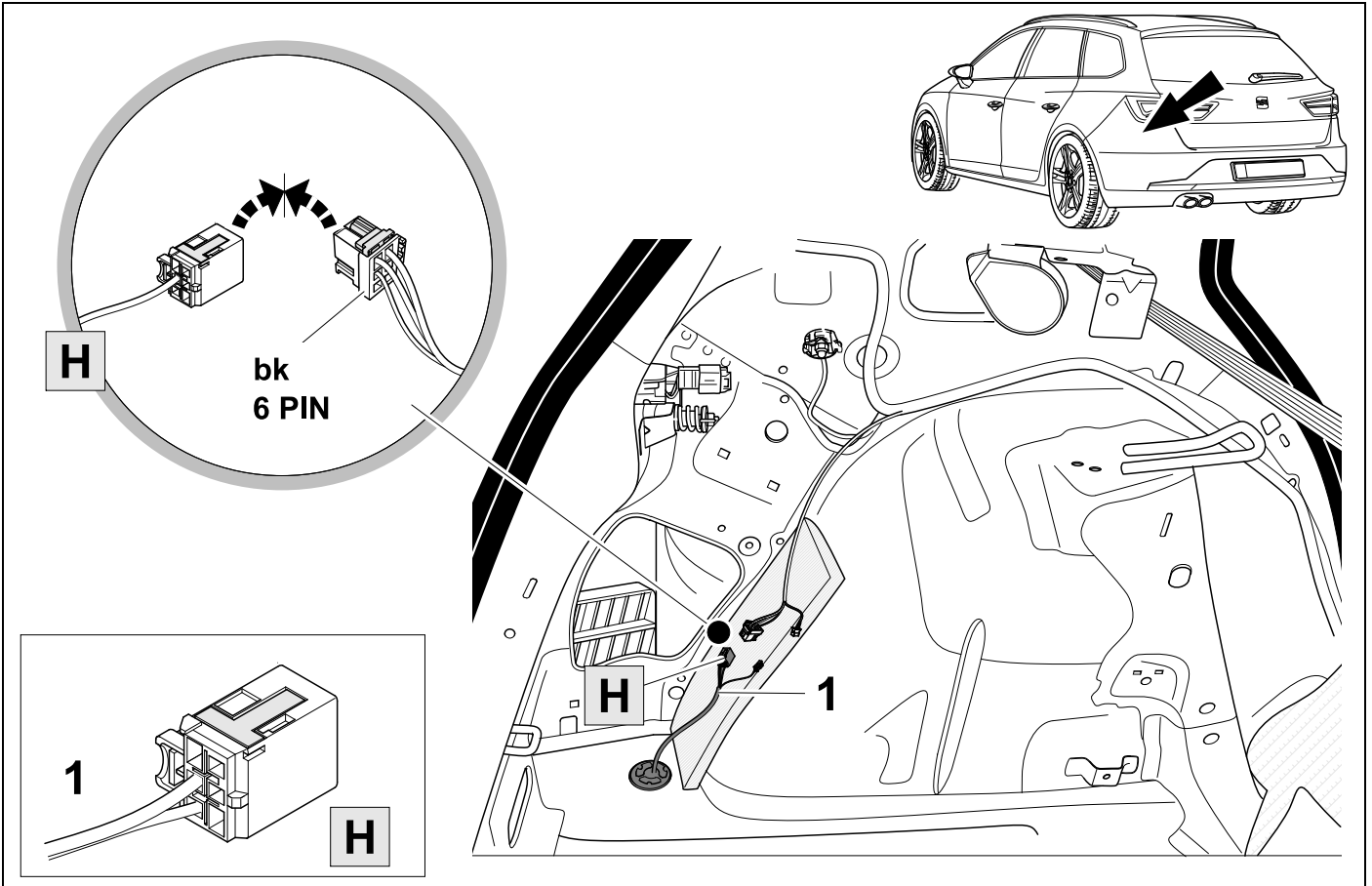

34



10

OPTION 5

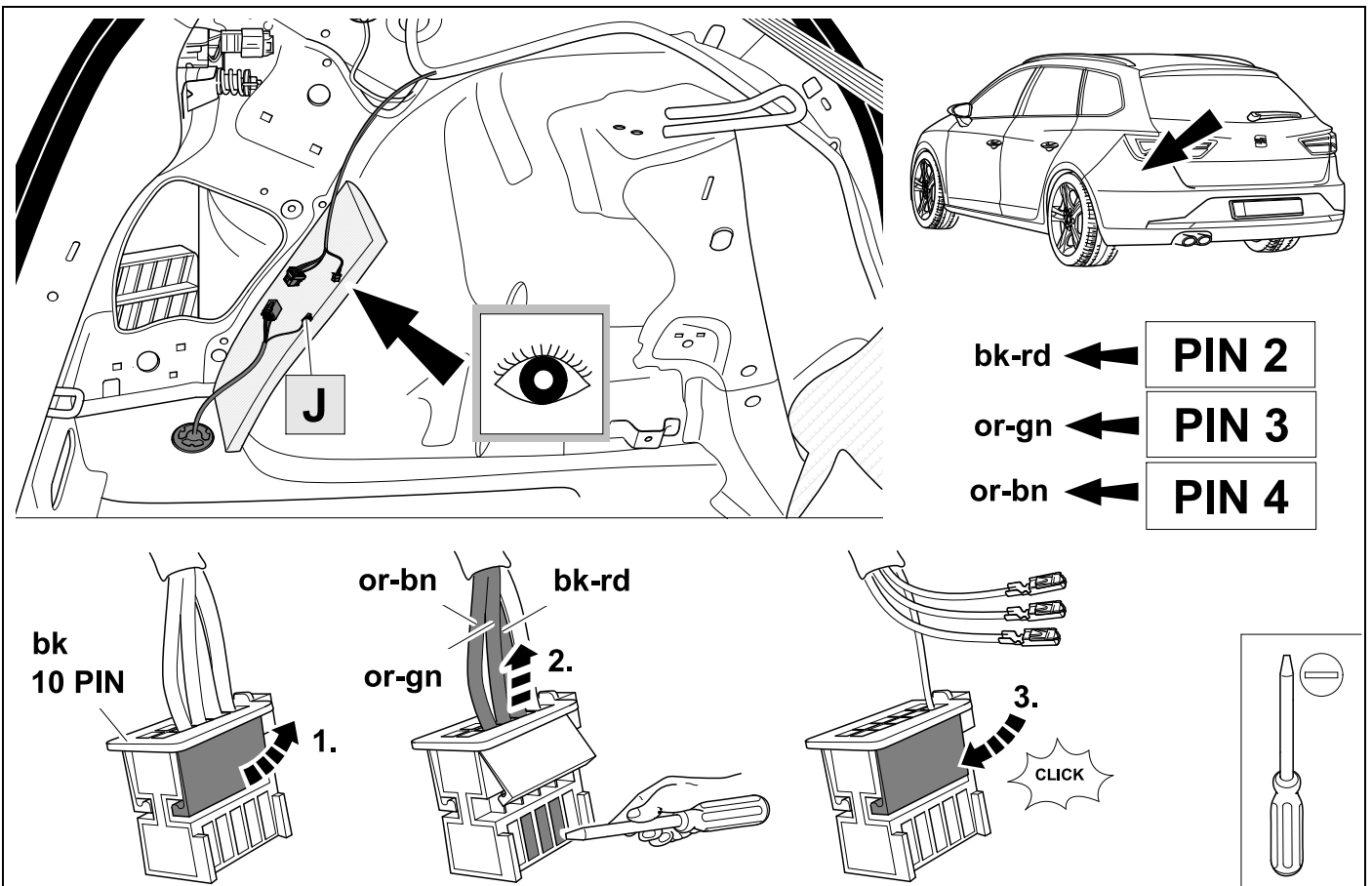

35



10

OPTION 5

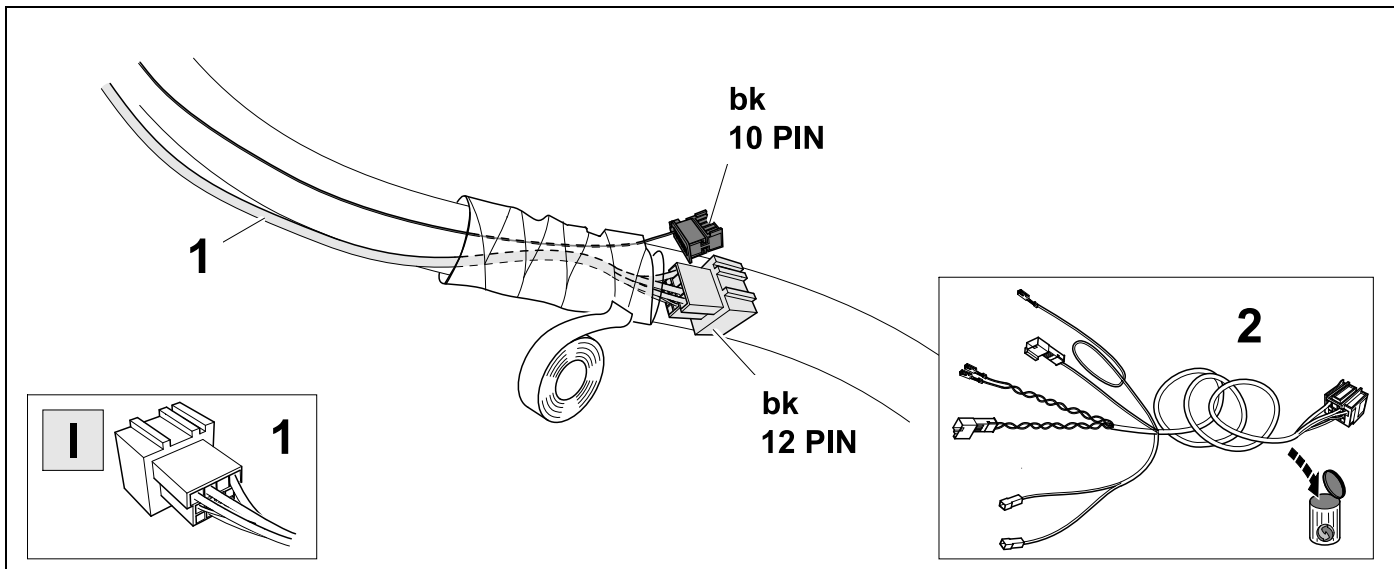

36



10

OPTION 5

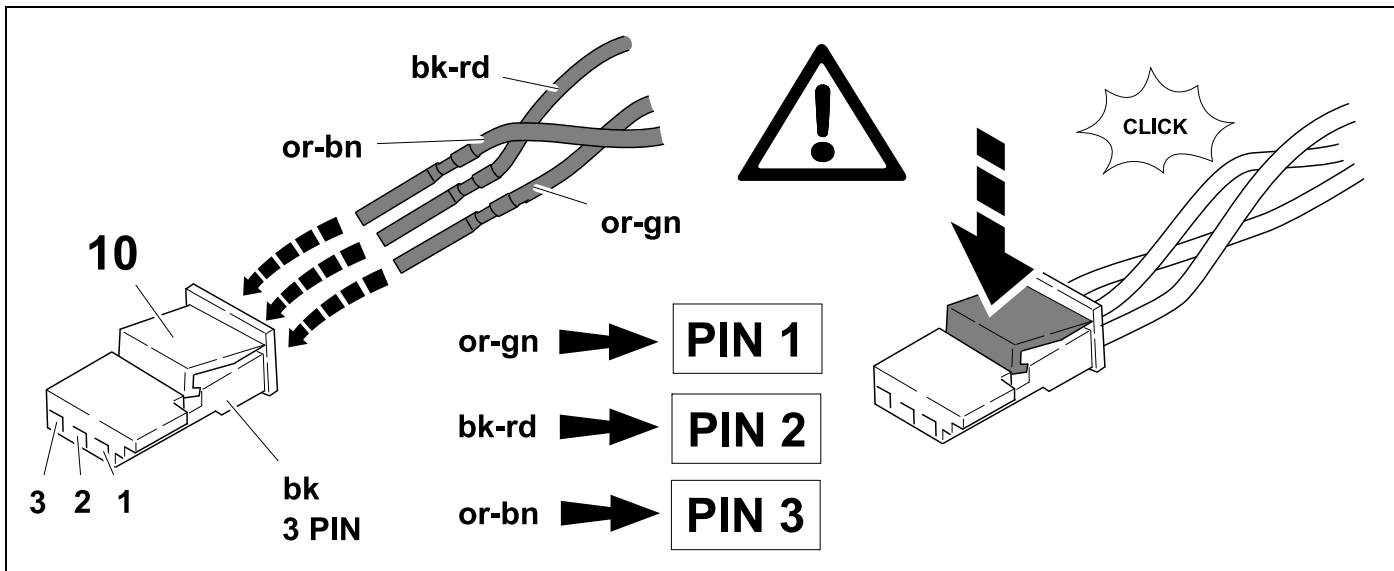

37

OPTION 5

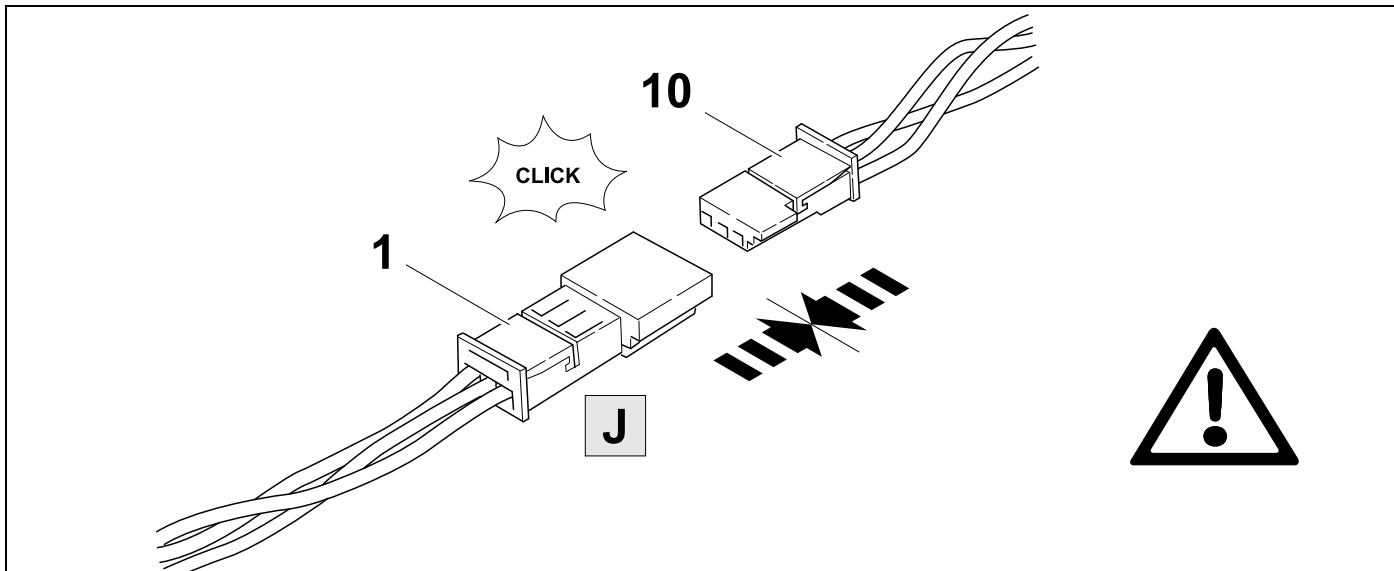

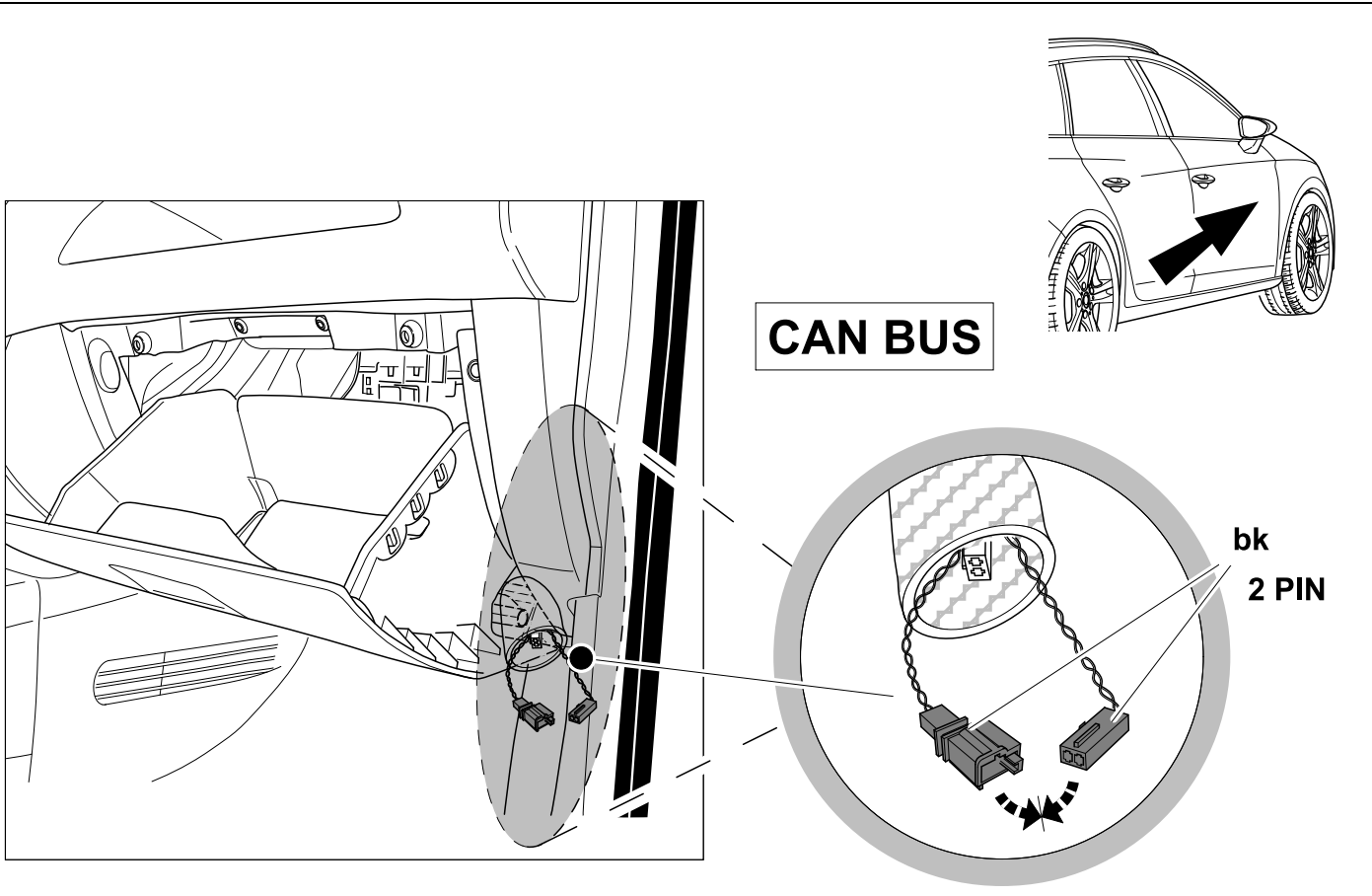

39 OPTIONAL

764159

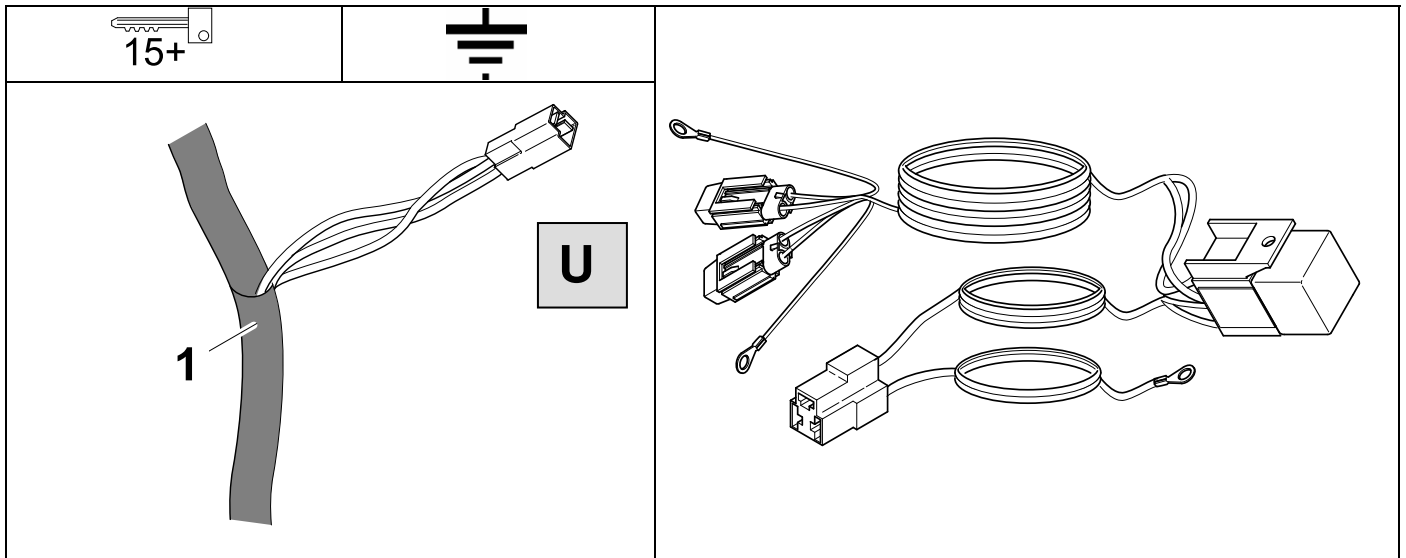

40

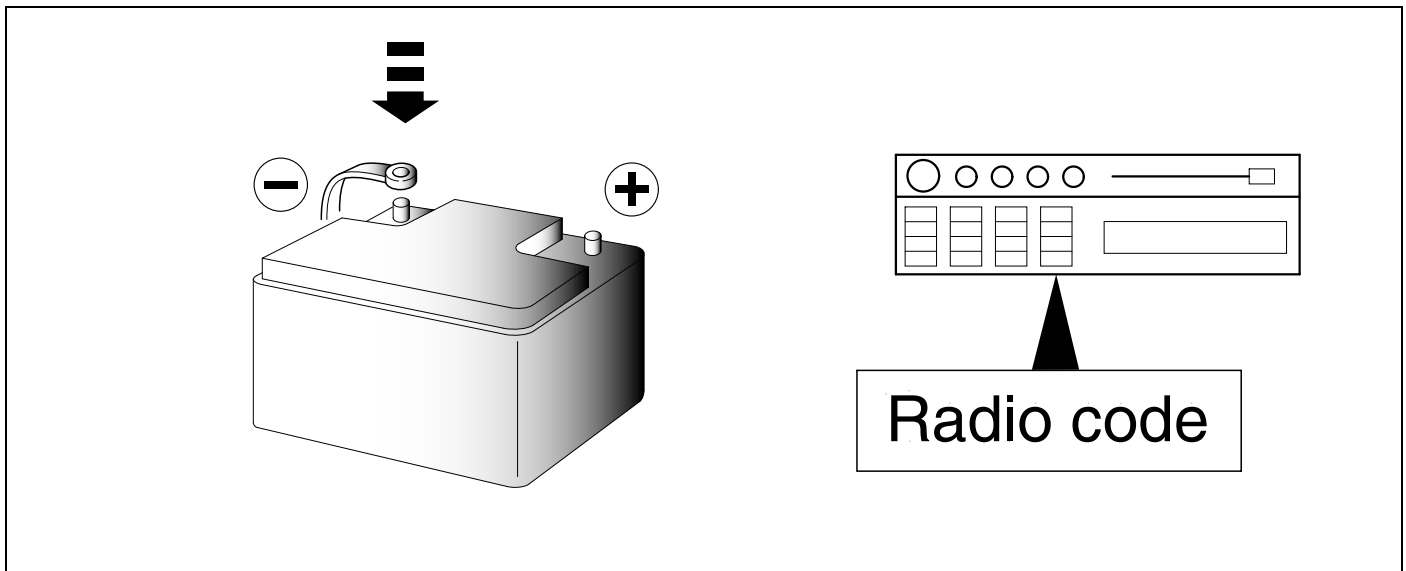

41 CHECK

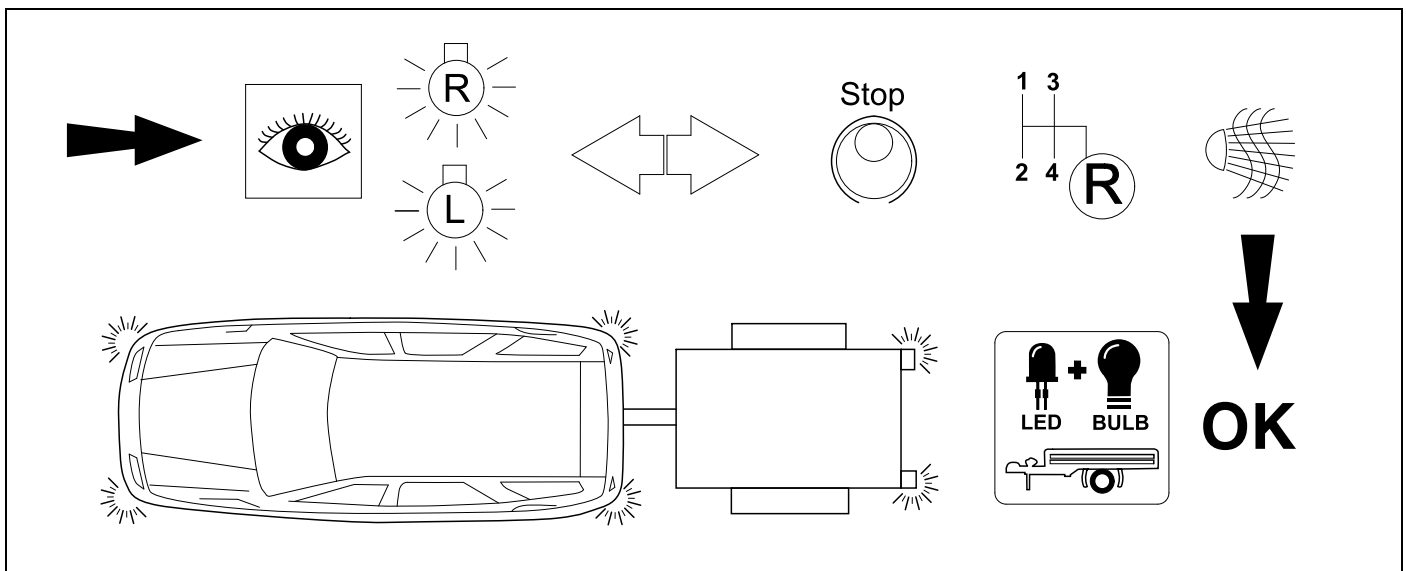

42 OPTIONAL

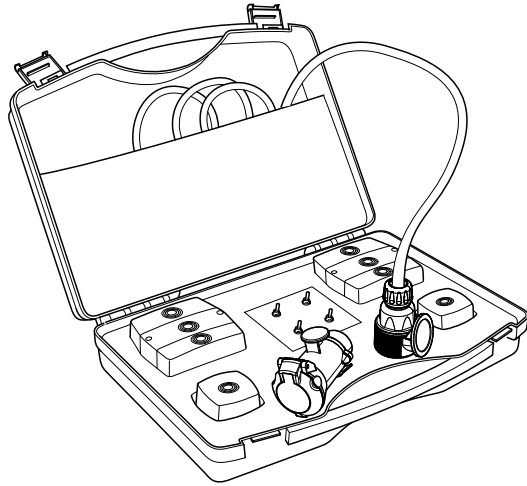

**Trailer Simulator
for 7p and 13p
sockets**

765069

43 CHECK

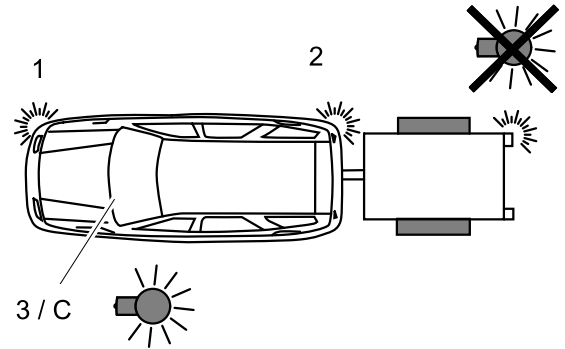
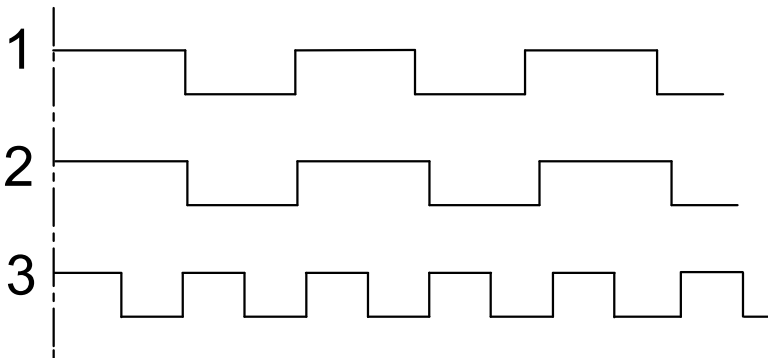

44 Information Service



17

-

18

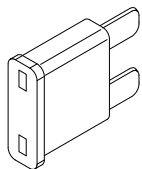

20 A

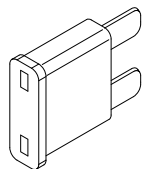
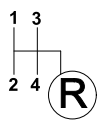
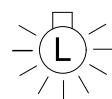
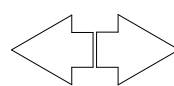
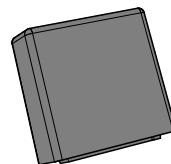
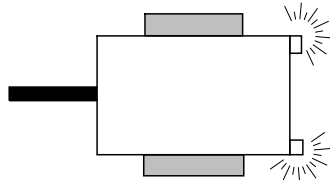

15 A

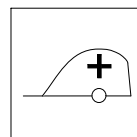
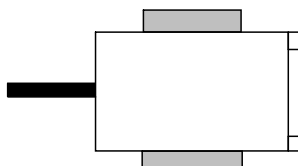

Stop

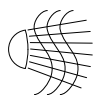
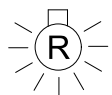

45

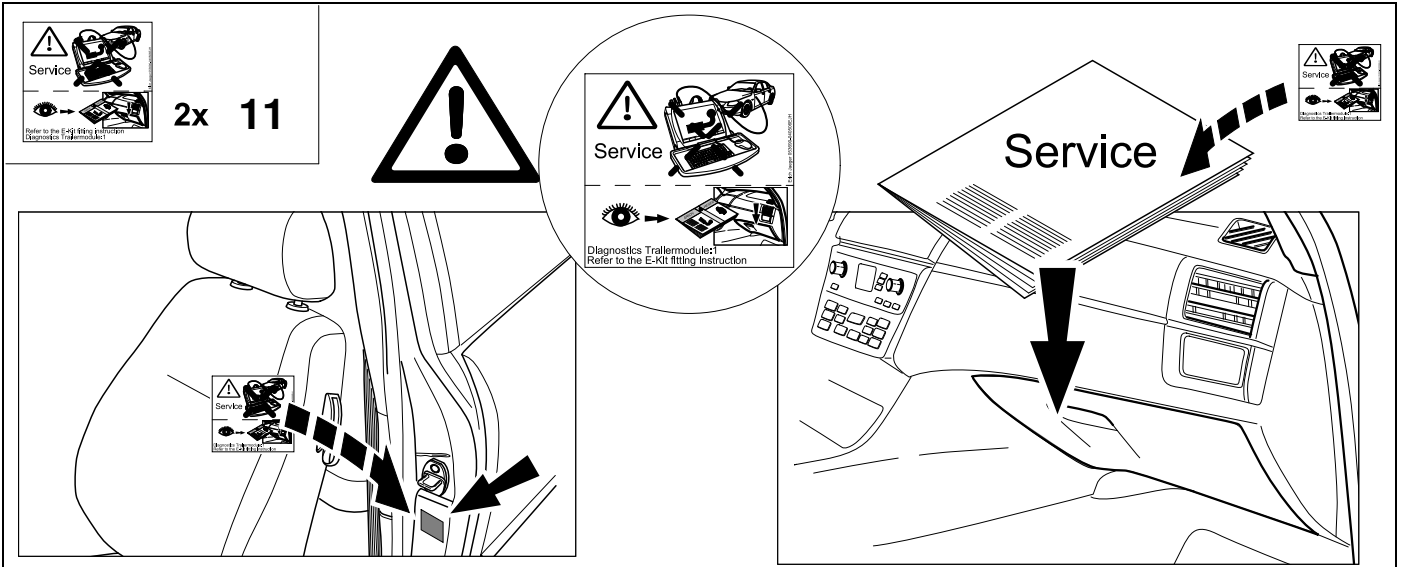

46 OPTIONAL



BRINK

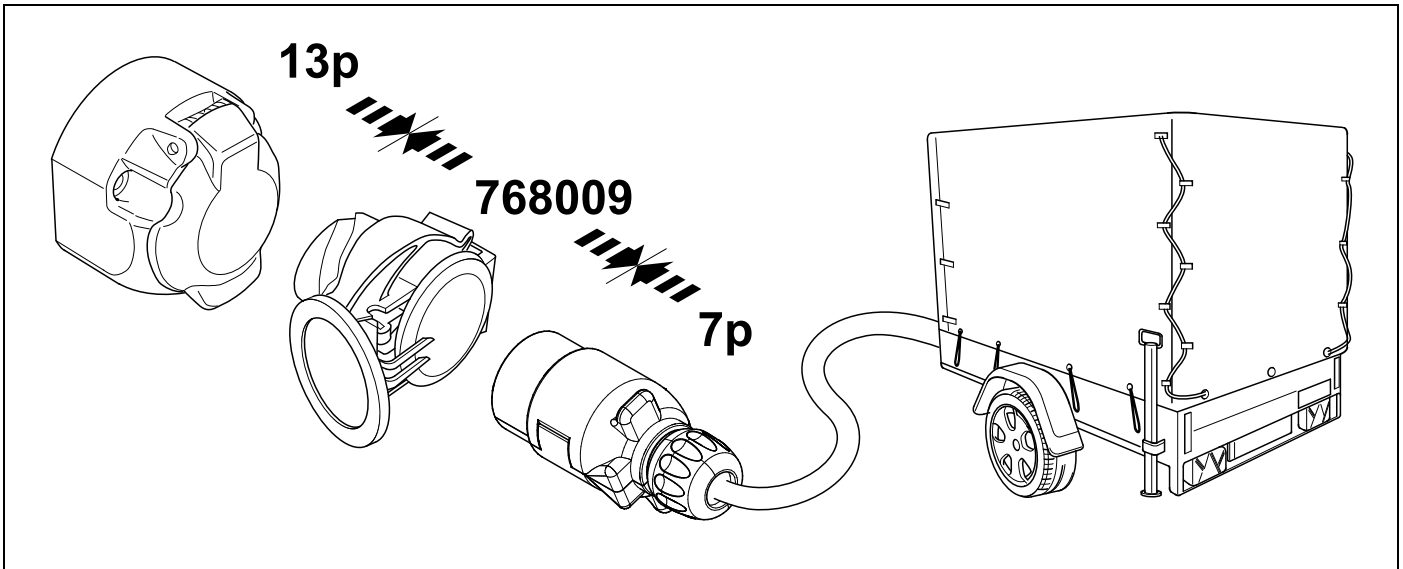

47 PLEASE NOTICE

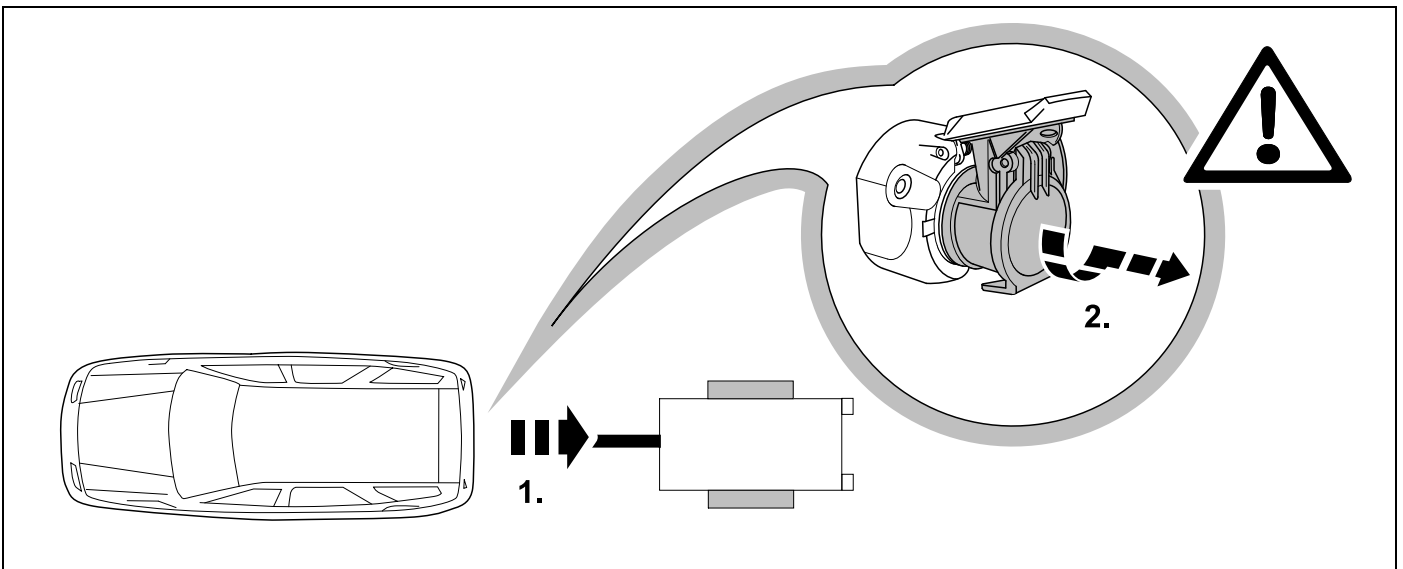

48 PLEASE NOTICE



Need help programming this wiringkit?

Use Jifeline to program this wiringkit

Please check the voucher added to this wiringkit and learn how to program this wiringkit with Jifeline.

49

PR: 1D8

**Fahrzeuge mit PR: 1D8
Vorbereitung sind
bereits Codiert.**

**Vehicles with PR: 1D8
preparation already
coded.**

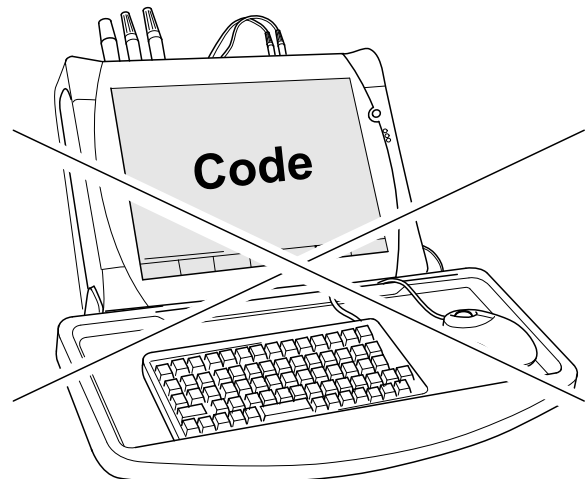

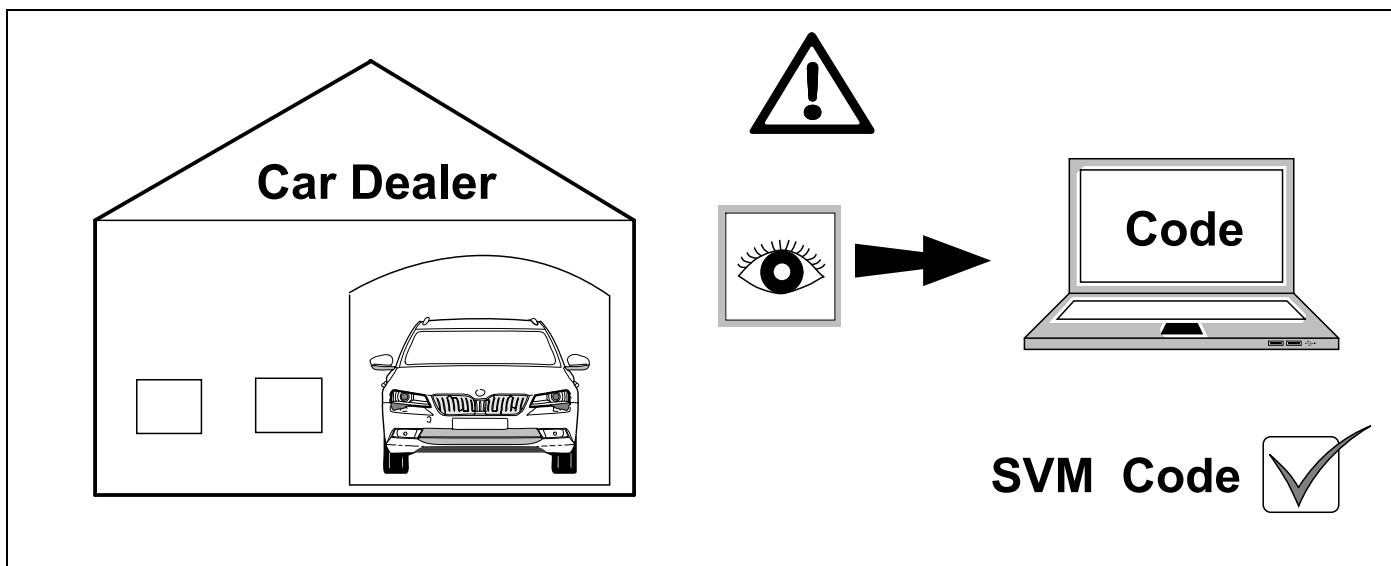

<p style="text-align: center;">D</p> <p>Nach Verbau des Elektro-Umrüstsatzes muss eine Online-Codierung bzw. Rückdokumentation mittels ODIS wie folgt durchgeführt werden:</p> <ul style="list-style-type: none"> • ODIS- Diagnosetester starten • Funktion „Diagnose“ starten • „Sonderfunktionen“ auswählen • „SW anpassen“ auswählen • Mit „Prüfung durchführen“ bestätigen • Auswählen Software Aktualisierung über Massnahmencode • SVM- Code im Eingabefenster eintragen und bestätigen Code: DA69AHV , DA69AHV123 • Anweisungen des Diagnosetesters befolgen 	<p style="text-align: center;">GB</p> <p>After fitting the electric installation kit, an online coding or a documentation update must be performed using ODIS as follows:</p> <ul style="list-style-type: none"> • Start ODIS diagnostic System • Start “Diagnostic” function • Select “Special functions” • Select “Adapt SW” • Confirm with “Perform test” • Select “Perform upgrading and retrofitting solutions” • Enter and confirm SVM- Code in the input window Code: DA69AHV , DA69AHV123 • Follow the instructions of diagnosis system 	<p style="text-align: center;">F</p> <p>Après avoir installé le faisceau d’attelage, il est nécessaire d’effectuer un codage en ligne ou une rétro-documentation à l’aide d’ODIS, comme suit :</p> <ul style="list-style-type: none"> • Démarrer le système de diagnostic ODIS • Activer la fonction «Diagnostic» • Sélectionner «Fonctions Spéciales» • Sélectionner «Adapter le logiciel» • Confirmer «Effectuer le contrôle» • Sélectionner «Rééquipements et post équipements » • Entrer et confirmer le code SVM dans la fenêtre de saisie Code: DA69AHV , DA69AHV123 • Suivre les instructions du système de diagnostic
<p style="text-align: center;">I</p> <p>Dopo aver installato il kit elettrico, è necessario effettuare la codifica online utilizzando il sistema diagnostico ODIS come segue:</p> <ul style="list-style-type: none"> • Avviare il sistema diagnostico ODIS • Avviare la funzione “Diagnostica” • Selezionare “Funzioni Speciali” • Selezionare “Adeguamento SW” • Confermare “Esegui Test” • Selezionare “Esegui aggiornamento /adeguamento” • Inserire e confermare il codice SVM nella finestra di input Code: DA69AHV , DA69AHV123 • Seguire le istruzioni del sistema diagnostico 	<p style="text-align: center;">E</p> <p>Tras la instalación del kit eléctrico, es necesario efectuar una codificación online o una documentación retrospectiva a través de ODIS de la manera siguiente:</p> <ul style="list-style-type: none"> • Iniciar el sistema de diagnostico ODIS • Iniciar la función “Diagnóstico” • Seleccionar “Funciones Especiales” • Seleccionar “Adaptar Software” • Confirmar “Efectuar Comprobación” • Seleccionar “Realizar adaptación y reequipamiento” • Entrar y confirmar el código SVM en la ventana de entradas Code: DA69AHV , DA69AHV123 • Seguir las instrucciones del sistema de diagnostico 	<p style="text-align: center;">NL</p> <p>Na installatie van de kabelset dient online codering plaats te vinden of een update in de documentatie middels ODIS systeem volgens de methode:</p> <ul style="list-style-type: none"> • Start ODIS diagnose Systeem • Start “Diagnostic” functie • Selecteer “Special functions” • Selecteer “Adapt SW” • Bevestig met “Perform test” • Selecteer “Perform upgrading and retrofitting solutions” • Enter en bevestig SVM- Code in het invoer veld Code: DA69AHV , DA69AHV123 • Volg de instructies van het diagnose systeem

Status LED für Eigendiagnose

Status LED for self-diagnosis

Operation support

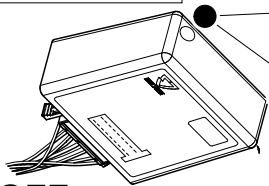
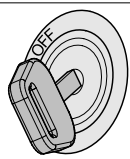

No CAN-Data =



Standby / Sleepmode

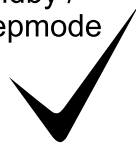

Ignition OFF

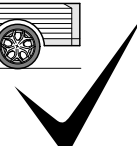
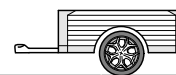
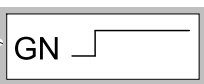
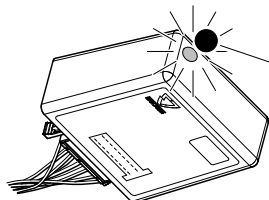

Ignition ON

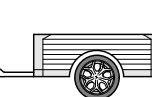
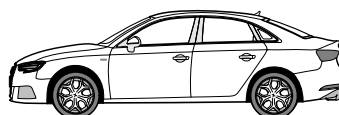
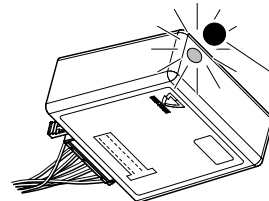

Ignition ON

Failure support

CAN-Data Wire



1x max. 5 min.

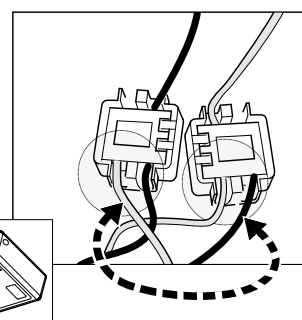
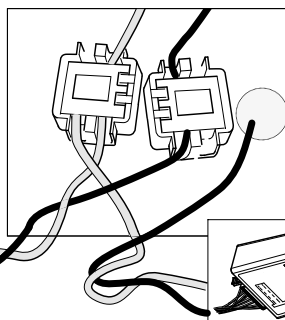
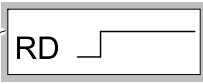
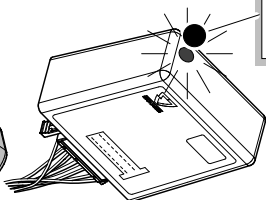

Ignition ON

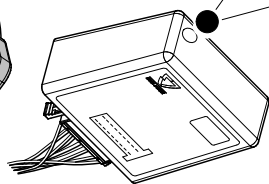
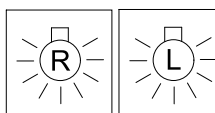

PIN 17 oder / or



PIN 1

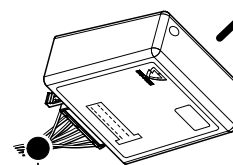
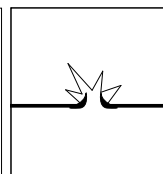
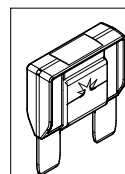
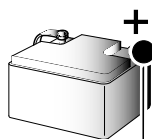

Ignition ON

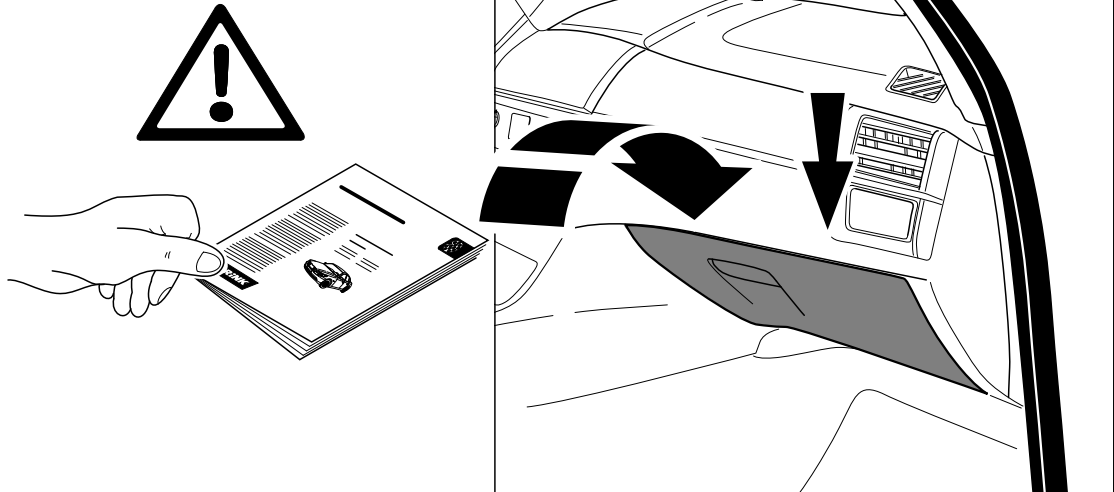

- | | |
|--|---|
| <p>(D) Änderungen bezüglich Konstruktion, Ausstattung Farbe sowie Irrtum vorbehalten.
Angaben und Abbildungen unverbindlich</p> <p>(GB) Subject to change in terms of construction, equipment and colour, and may contain errors.
The information and illustrations are non-binding.</p> <p>(F) Sous réserve de modifications de la construction, de l'équipement, de la couleur et sous réserve d'erreurs. Les indications et les illustrations sont sans engagement.</p> <p>(NL) Wijzigingen met betrekking tot constructie, uitvoering en kleur evenals vergissingen voorbehouden. Gegevens en afbeeldingen niet bindend.</p> <p>(DK) Ændringer med hensyn til konstruktion, udstyr, farver samt fejl forbeholdes.
Oplysninger og illustrationer er uforpligtende.</p> <p>(N) Endringer angående konstruksjon, utstyr, farge og feiltagelse forbeholdes.
Oplysninger og illustrasjoner uforbindtlig.</p> <p>(S) Med reservation för ändringar vad det gäller konstruktion, utrustning, färg samt för misstag. Uppgifterna och bilderna är inte bindande.</p> <p>(FIN) Pidätämme oikeuden rakennetta, varustusta, väriä koskeviin sekä erehdyksestä johtuviin muutoksiin. Tiedot ja kuvat eivät ole sitovia.</p> <p>(I) Con riserva di modifiche relative a progettazione, dotazione, colore ed errori.
Le indicazioni e figure sono fornite senza impegno.</p> <p>(E) Reservadas las modificaciones respecto a diseño, equipamiento, color, así como error. Indicaciones y figuras sin compromiso.</p> <p>(P) Reservamos o direito de alterações relativamente ao desenho, equipamento, cor, bem como de erro. Os dados e as gravuras não implicam compromisso da nossa parte.</p> <p>(GR) Διατηρούμε κάθε επιφύλαξη ως προς αλλαγές σε σχέση με κατασκευή, εξοπλισμό, διαρρυθμίση, χρωματισμούς και λάθη παραδρομής.</p> <p>(CZ) Změny, týkající se konstrukce, vybavení, barvy, jakož i omyly jsou vyhrazeny.
Údaje a vyobrazení jsou nezávazné.</p> | <p>(PL) Zastrzega się prawo do zmian dot. konstrukcji, wykończenia, kolorystyki oraz pomylek.
Dane i ilustracje niewiążące.</p> <p>(TR) Tasarım, donanım ve renk bakımından değişiklik yapma hakkı ve hata ve eksiklik mahfuzdur. Veriler ve resimler bağlayıcı değildir.</p> <p>(H) A szerkezet, a kivitell és a szín változtatása, valamint a változások joga fenntartva.
Az adatok és az ábrák nem kötelező érvényűek.</p> <p>(HR) Pravo promjena u svezi konstrukcije, opreme, boje kao i zabune oridžavamo.
Podaci i ilustracije su neobavezne.</p> <p>(BUL) Запазени права по отношение на конструкцията, обзавеждането, цвета и грешки.
Данните и изображенията не са обвързващи.</p> <p>(RO) Ne rezervăm dreptul unor modificări ale construcției, dotării, culorii și dreptul la erori
Datele indicate și imaginile sunt orientative.</p> <p>(RU) Права на внесение изменений относительно конструкции, оснащения, окраски, а также на ошибки сохраняются. Данные и иллюстрации имеют примерный характер.</p> <p>(LT) Pasiliekaama konstrukcijos, įrangos bei reikmenų, spalvos pakeitimų ir klaidų teisė.
Duomenys ir iliustracijos neįpareigojantys.</p> <p>(LV) Tiek paturētas tiesības uz konstrukcijas, iekārtu, krāsu izmaiņam, kā arī kļūdīšanās.
Dati un attēli bez saistībām.</p> <p>(EST) Konstruktsiooni, varustuse ja võervi osas muudatused ning eksimine lubatud.
Andmed ja joonised on mittesiduvad.</p> <p>(SLO) Zadržana pravica do sprememb glede konstrukcije, opreme, barve ter pomote.
Podatki in slike so neobvezne.</p> <p>(SK) Zmeny, ktoré sa týkajú konštrukcie, vybavenia, farby, ako aj omyly sú vyhradené.
Údaje a zobrazenia sú nezáväzné.</p> |
|--|---|