

x 2

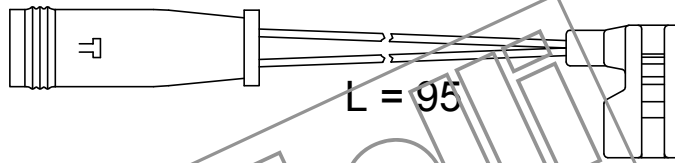

L = 95

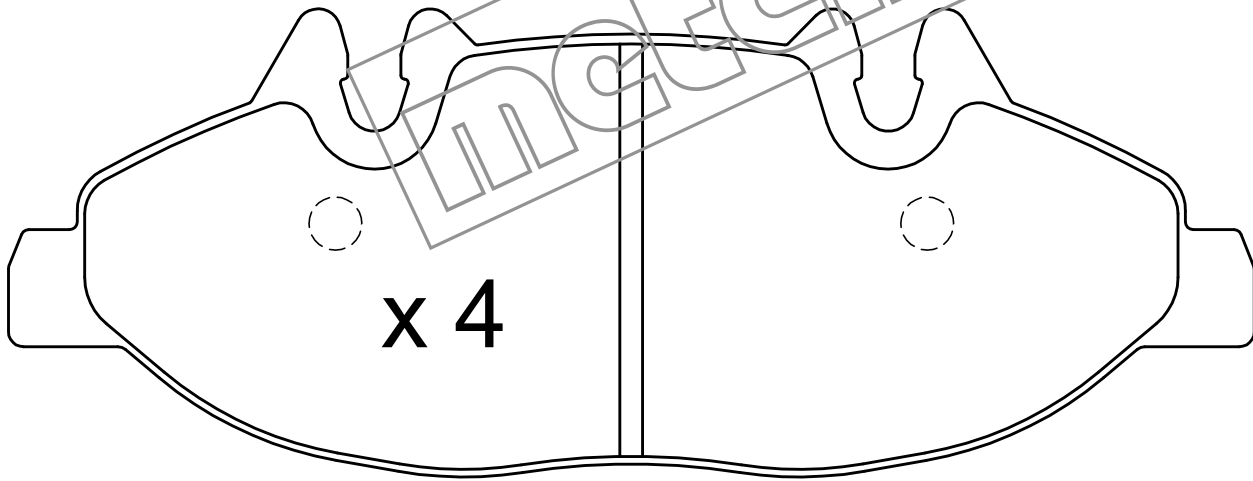

x 4

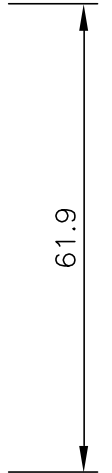

61.9

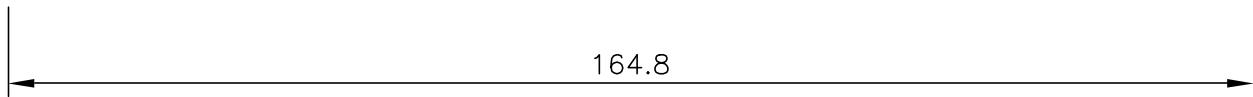

164.8

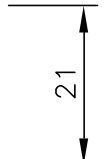
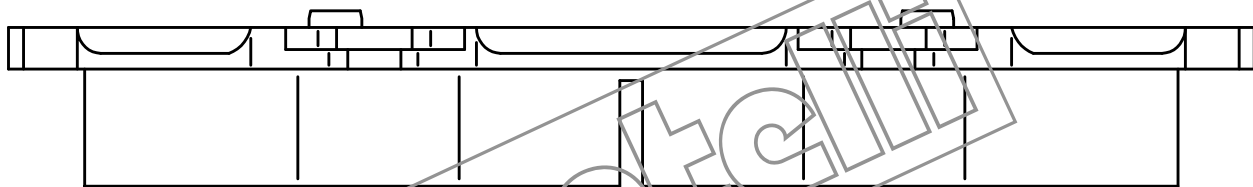

21

metelli