

L = 205

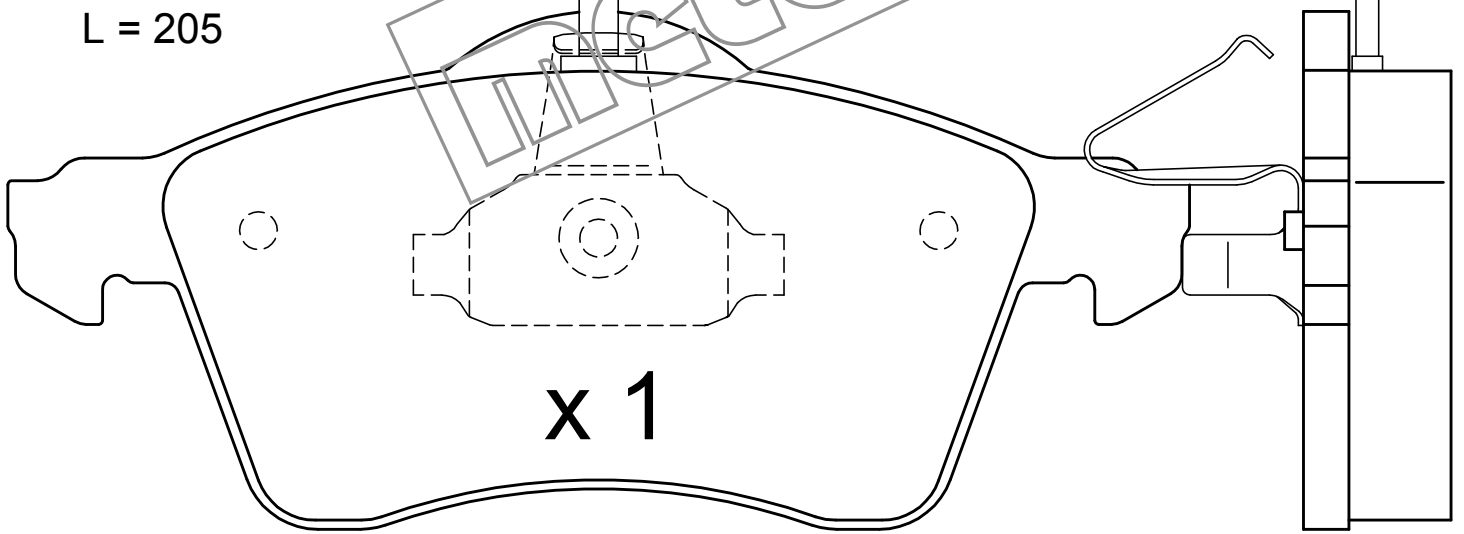

x 1

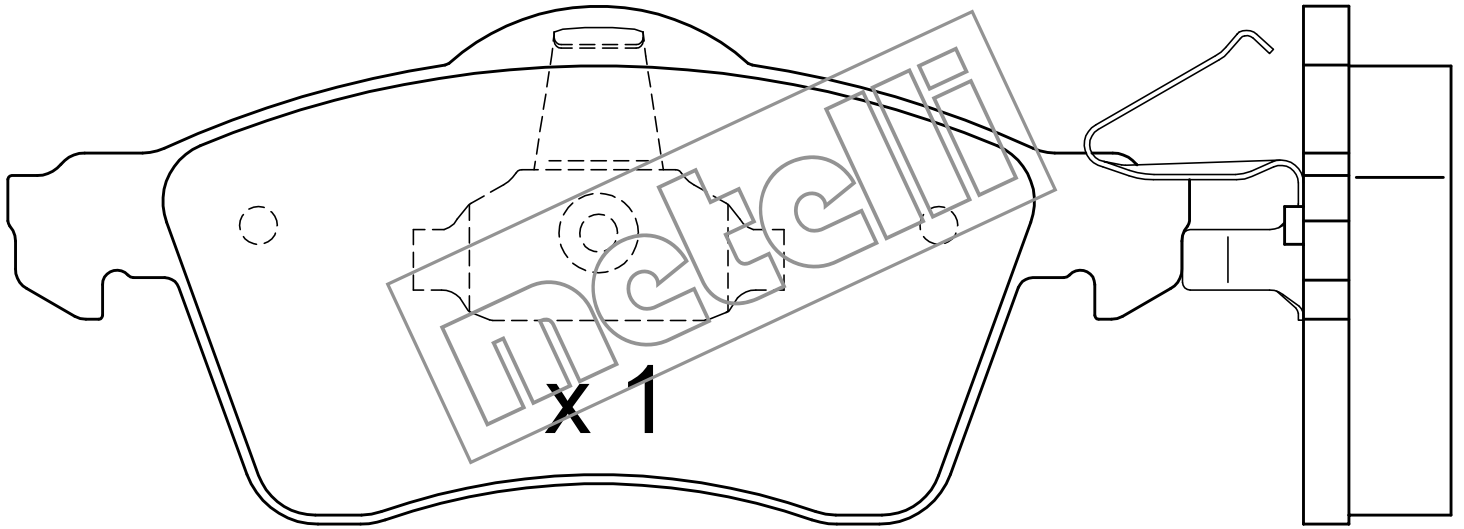

x 1

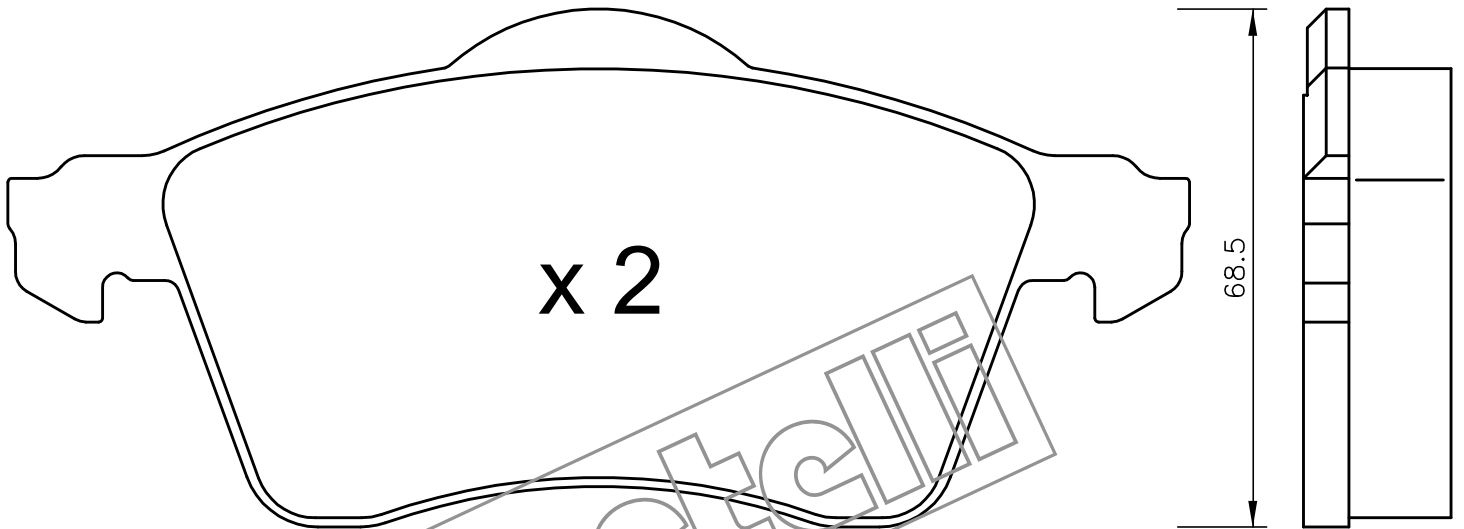

x 2

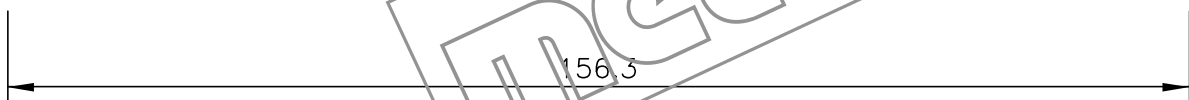

156.5

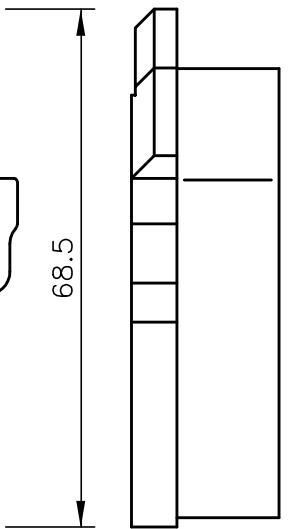

68.5

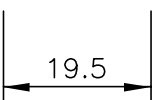

19.5