

x 1

L = 225

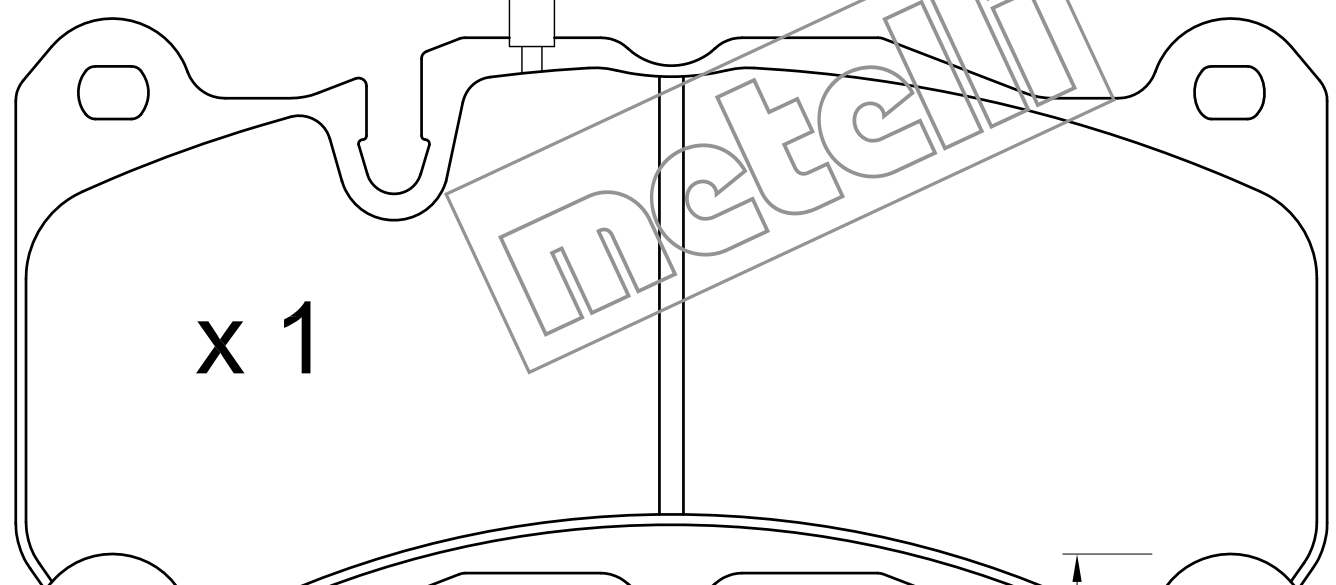

x 1

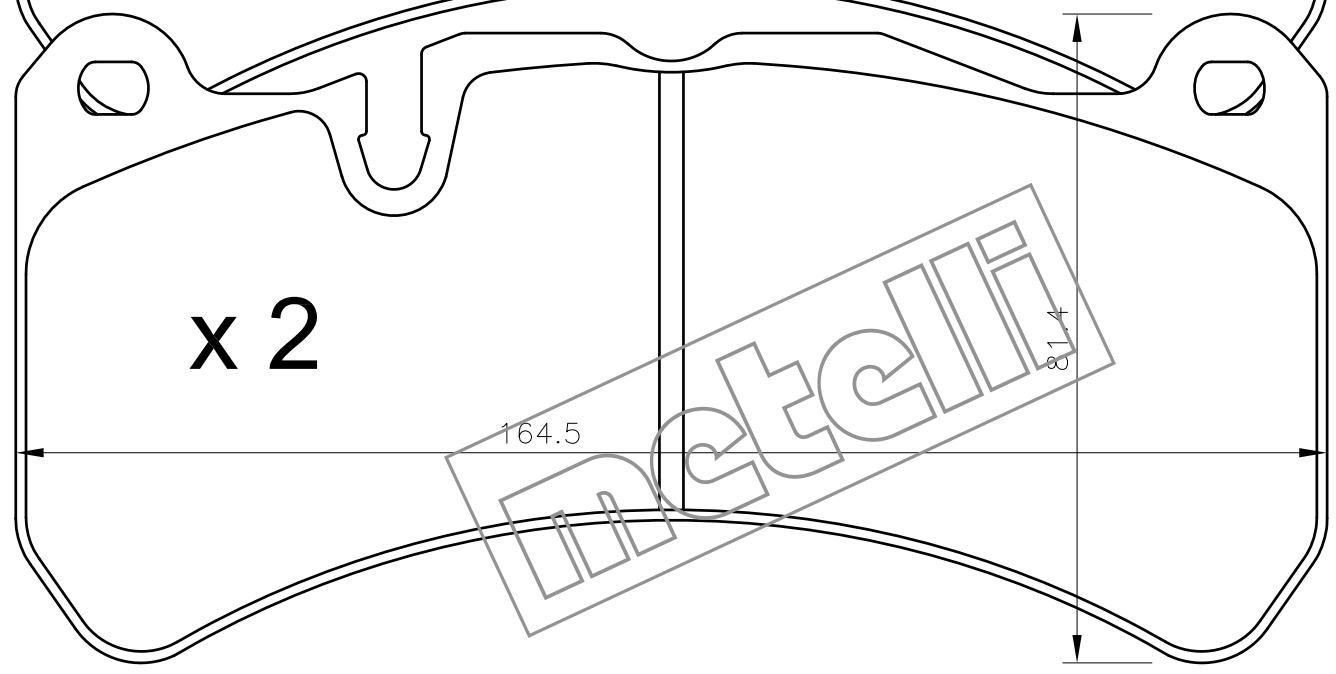

x 2

164.5

81.4

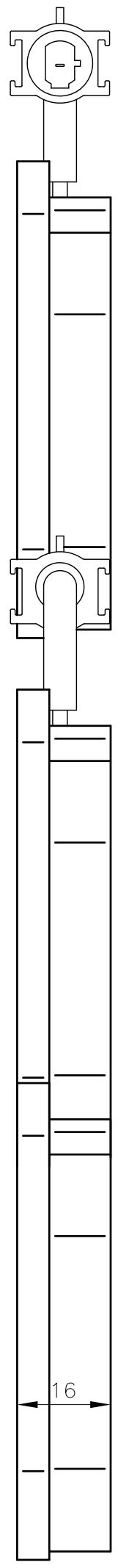

16