

Fact Sheet

INA Engine KIT 560 0005 10

Relevant Applications

Manufacturer: FORD, VOLVO

Vehicle: FOCUS II, KUGA, MONDEO IV, S-MAX, C30, S40 II, S60 II, S80 II, V40, V50, V60, V70 III, XC60 XC70 II

Engine: 2.5l 5 Cyl.

Car Parc: 0.4 million worldwide

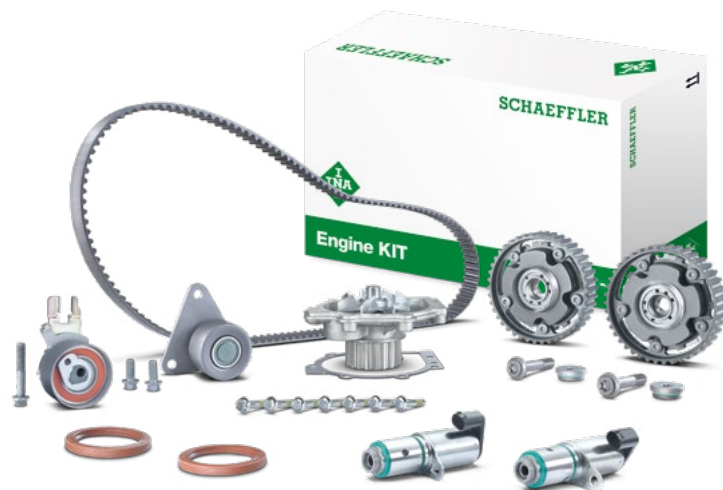

Contents of the INA Engine KIT

Timing belt, tensioner pulley, deflection pulley, water pump including seal, camshaft phasing units, control valves, all relevant seals, bolts and accessories

Technical Context

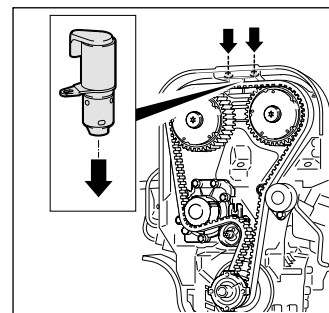
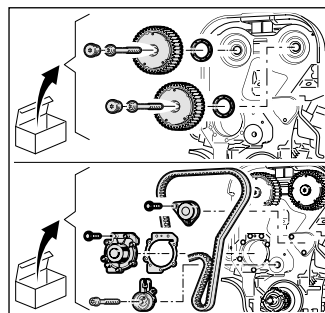
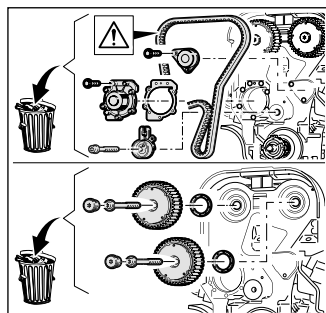
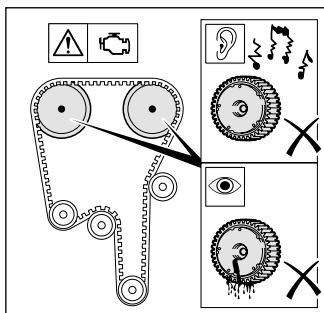

The control valve filters are clogged due to dirt and abrasion. As a result, the camshaft phasing units are not supplied with sufficient engine oil and are irreparably damaged. This damage is evident in the form of a significant noise generation and/or oil leakage.

The timing belt must be removed in order to replace the faulty camshaft phasing units. As the timing belt must be replaced at defined intervals, for economic purposes it usually makes sense to also replace the complete timing belt drive together with the tensioner pulley, the deflection pulley and the water pump. In the event of oil leakage, the timing belt drive must be replaced!

All relevant components (including bolts and seals) are provided in the INA Engine KIT and must always be used for the repair.

In order to ensure that the new camshaft phasing units operate correctly, the control valves included in the INA Engine KIT must be used.