

x 1

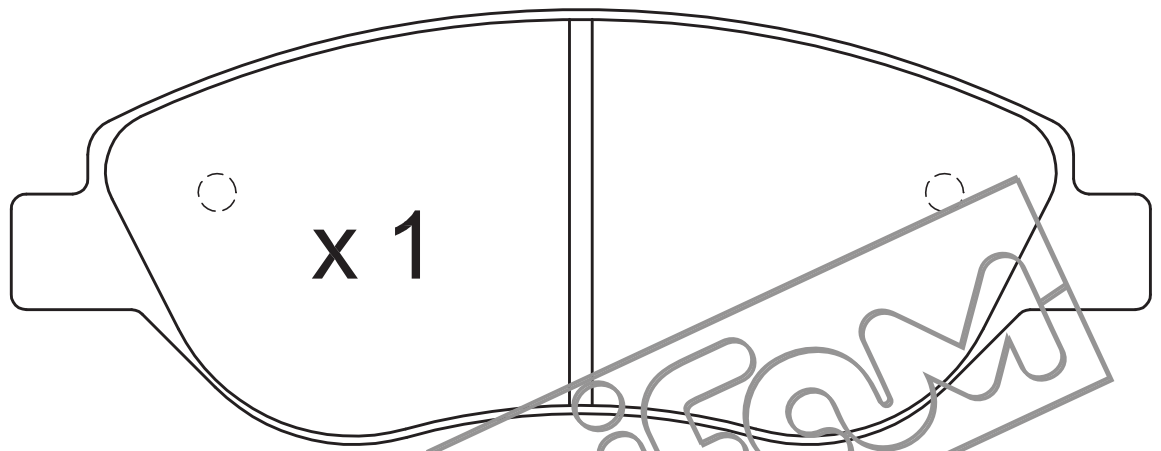

x 1

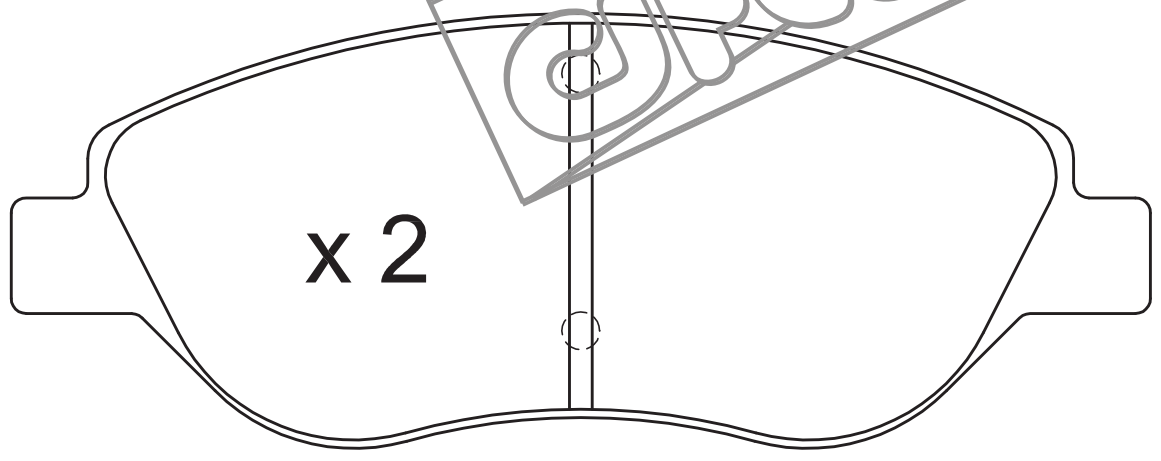

x 2

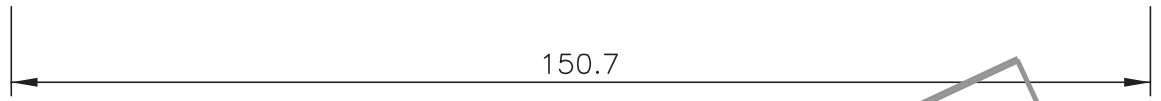

150.7

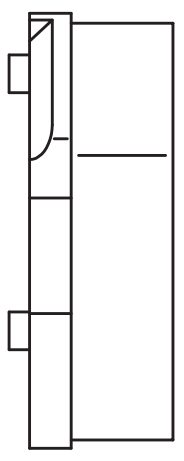
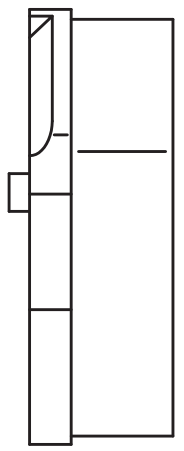
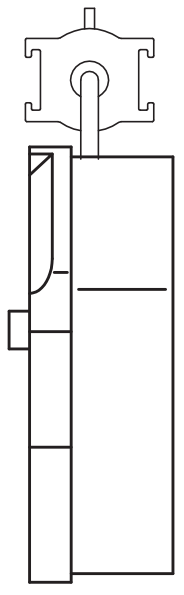

57.6

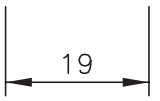

19

