

x 2

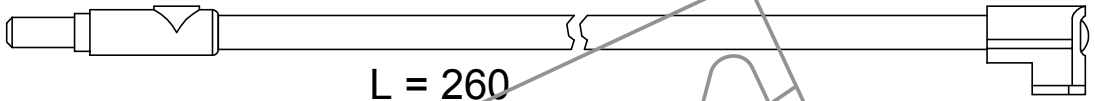

L = 260

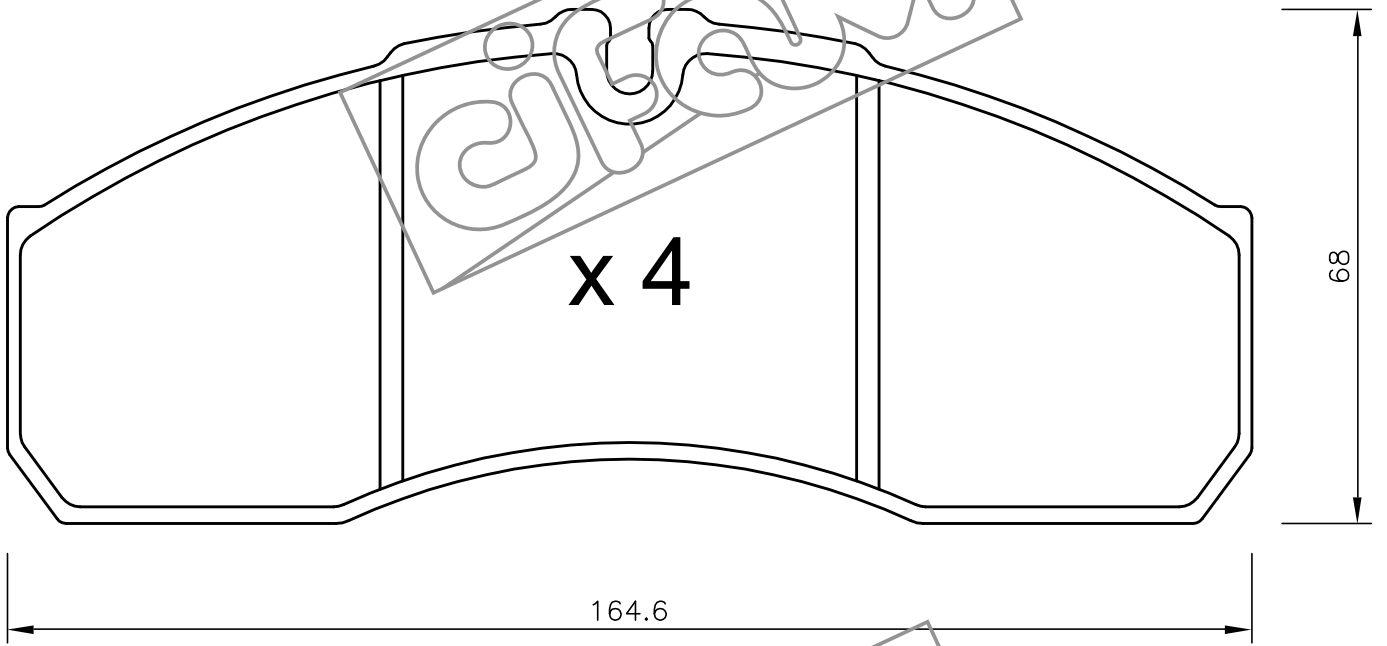

x 4

164.6

68

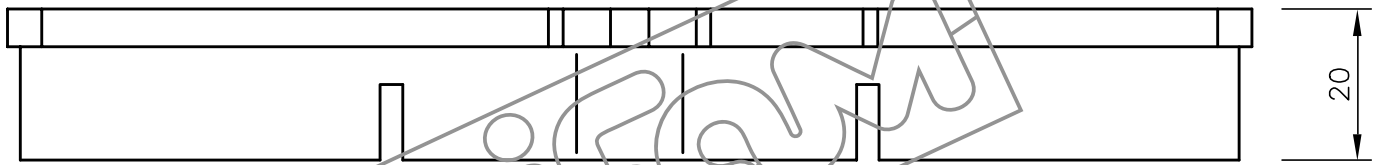

20

