

x 2 L = 160

x 2 L = 255

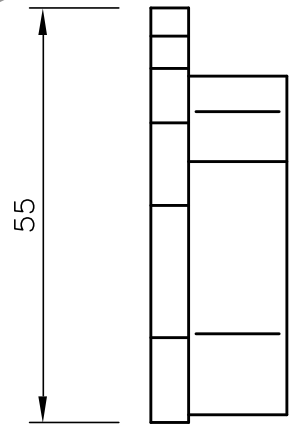
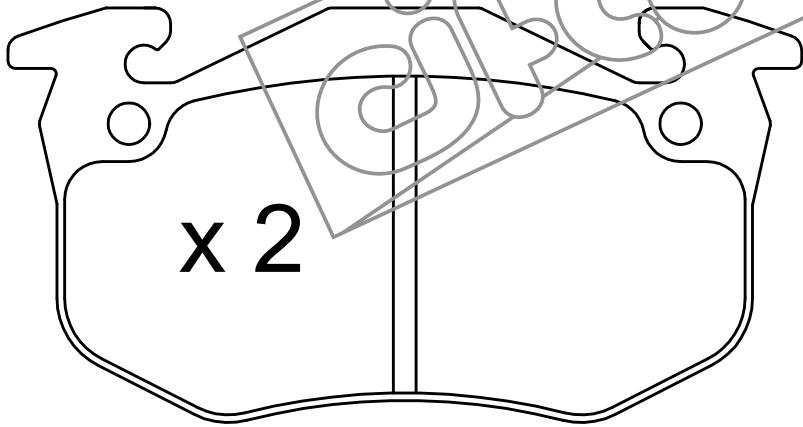
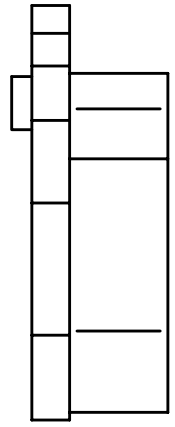
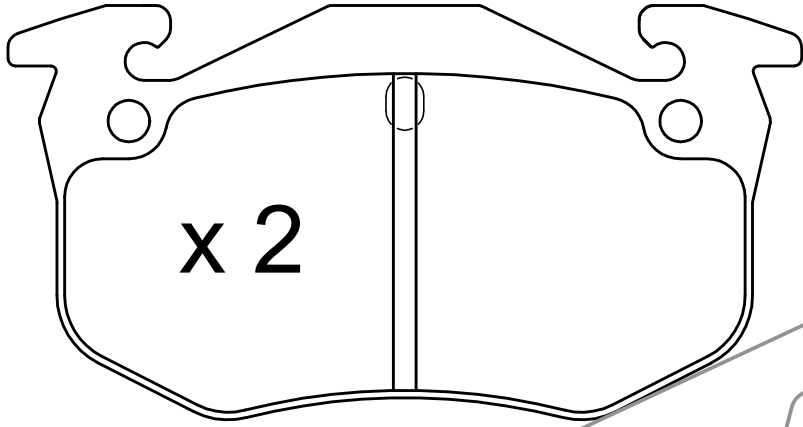

105.1

18

