

L = 205

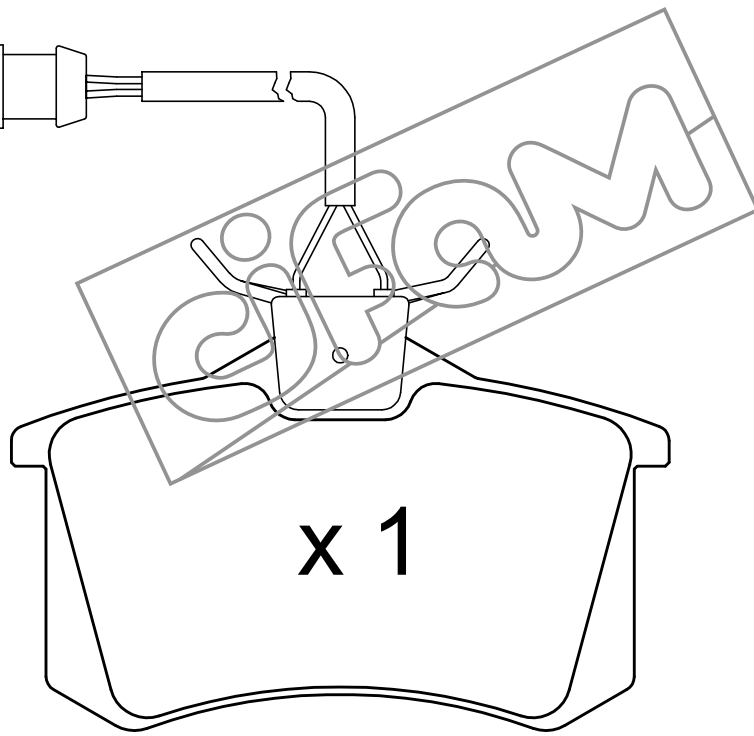

x 1

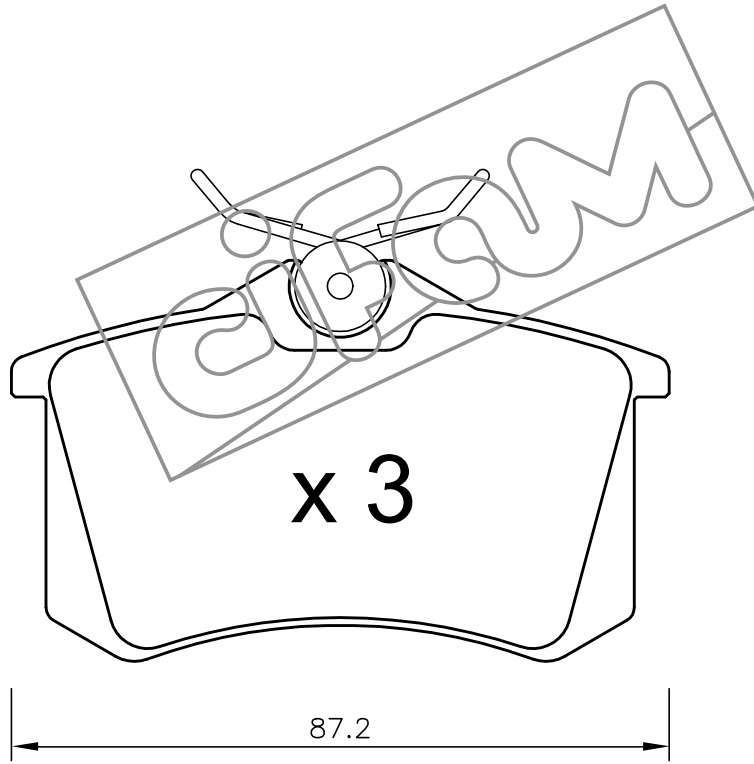
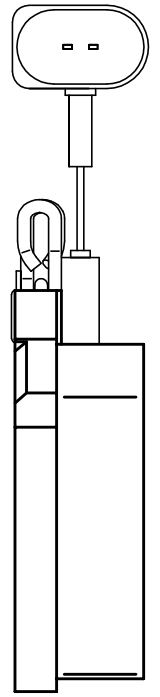

x 3

87.2

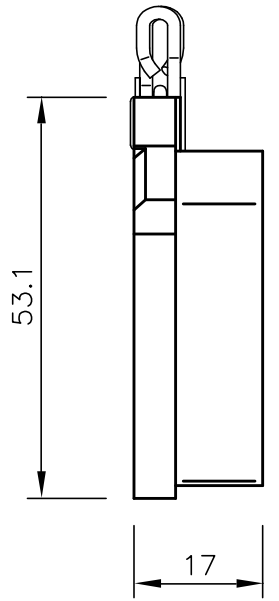

53.1

17

