

x 2

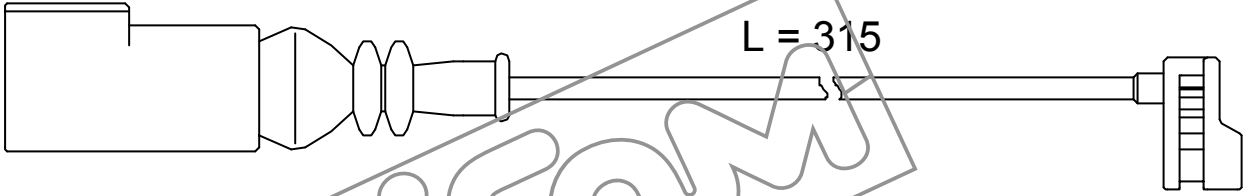

L = 315

x 4

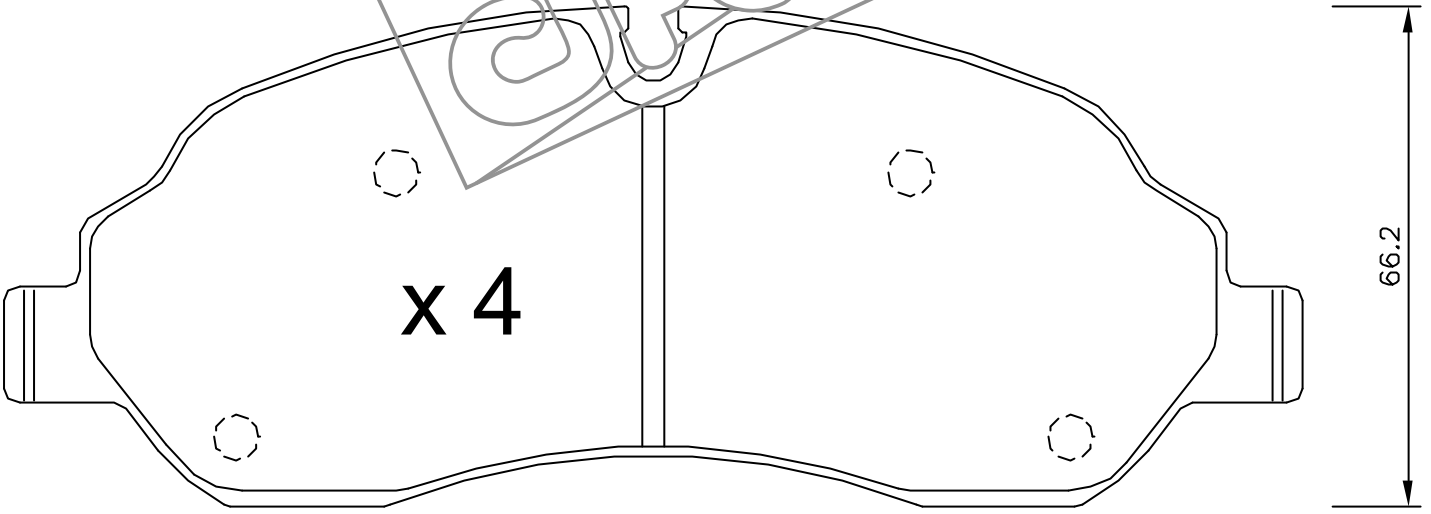

66.2

171.8

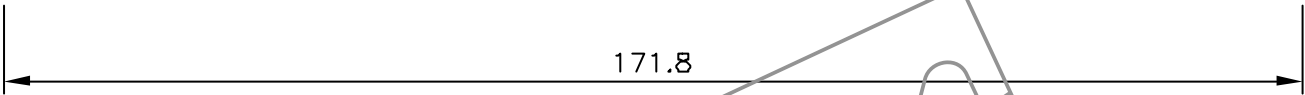

17

