

x 2

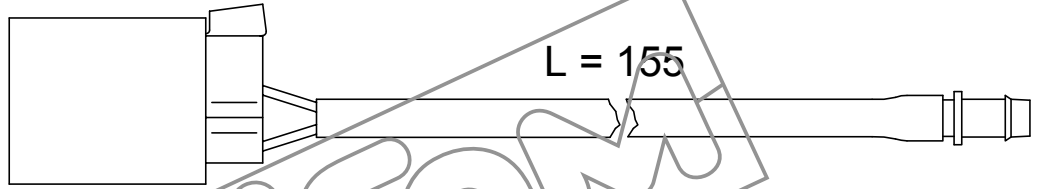

L = 155

x 4

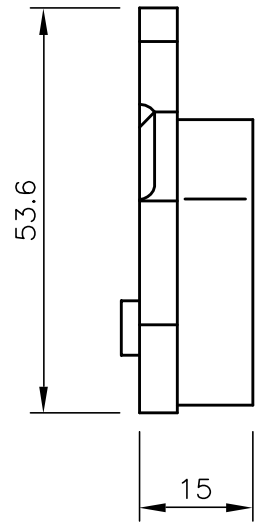
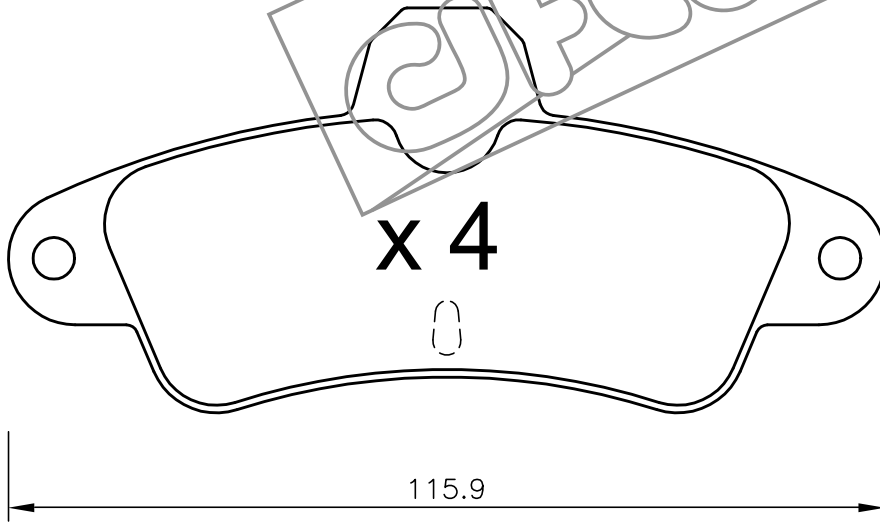

115.9

53.6

15

