

x 1

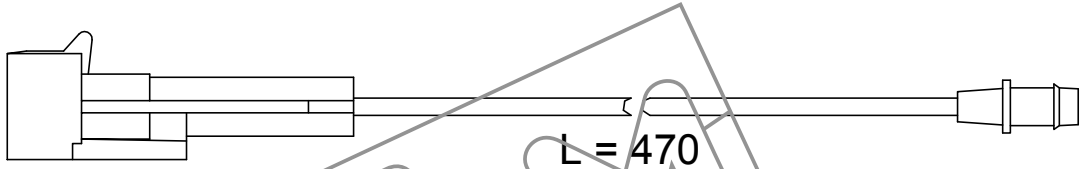

L = 470

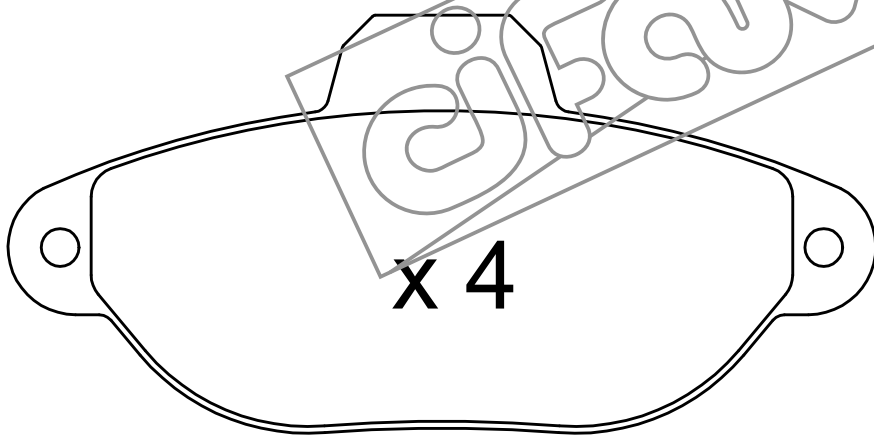

x 4

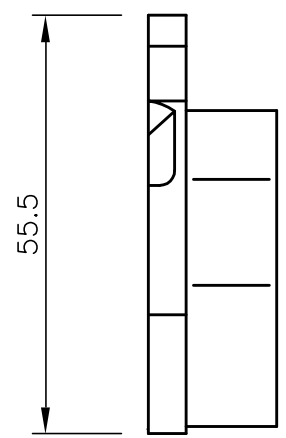

55.5

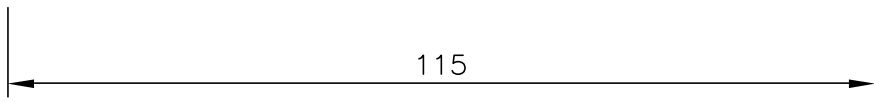

115

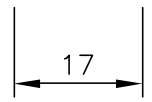

17

