



ATTENTION



**INSTALLATION OF THIS AIR SUSPENSION COMPRESSOR
REQUIRES THE REPLACEMENT OF THE COMPRESSOR RELAY.**

**FAILURE TO REPLACE THE OE RELAY WITH THE UNIT PROVIDED IN
THIS KIT CAN CAUSE DAMAGE AND/OR VOID WARRANTY.**

PLEASE REFER TO YOUR VEHICLES SHOP MANUAL OR CONSULT YOUR LOCAL DEALERSHIP FOR
ADDITIONAL INFORMATION AND PROPER PROCEDURES FOR REPLACING YOUR AIR SUSPENSION
COMPRESSOR RELAY.

P-2134/P-3297

P-2291/P-3299/P-3305



01-05 AUDI ALLROAD QUATTRO (C5)
Relay located on the left side of the vehicle under the dashboard.

04-09 JAGUAR XJ SERIES (X350/358)
Relay located on the right side of the vehicle in the engine compartment.

P-2192/P-3296

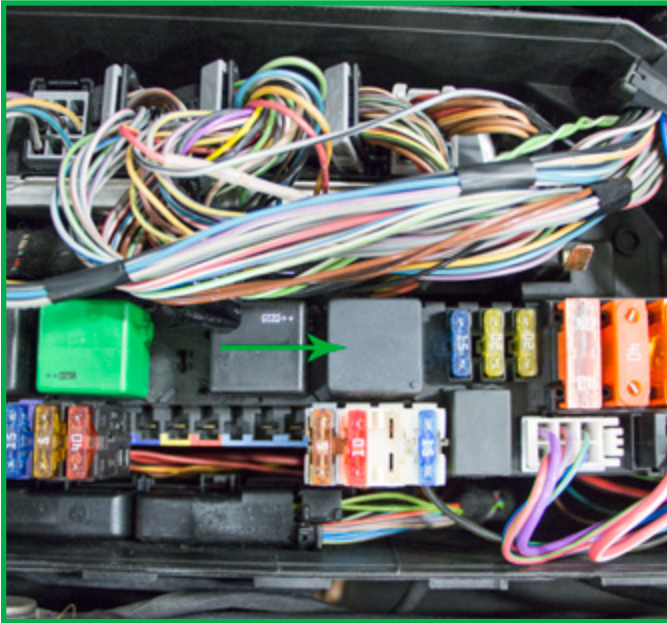

00-06 MERCEDES-BENZ S-CLASS
Relay located on the right side of the vehicle in the engine compartment.

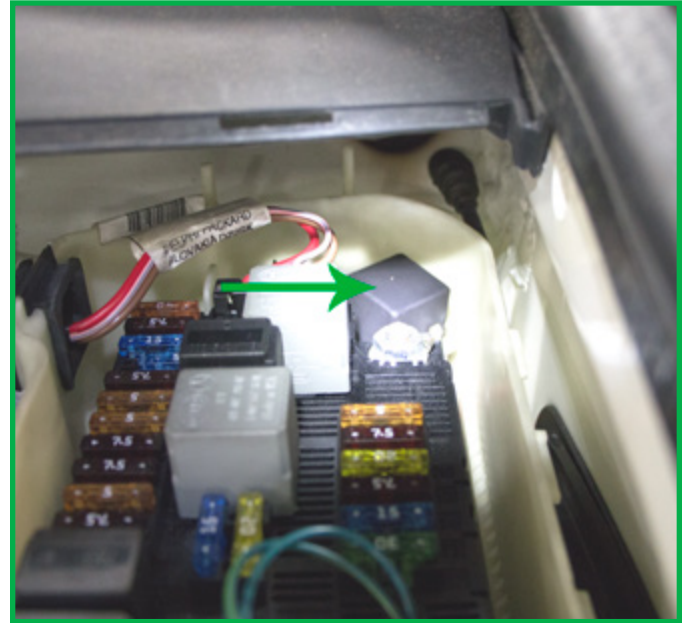

02-09 MERCEDES-BENZ E-CLASS
Relay located on the left side of the vehicle by the firewall.

P-2539/P-2599

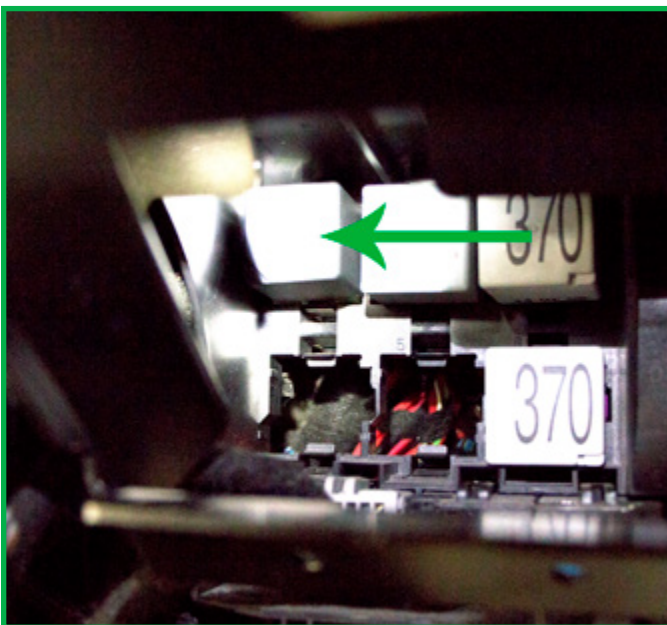

04-10 AUDI A8 QUATTRO (D3)
Relay located on the left side of the vehicle under the dashboard.

P-2984/P-3302/P-3317

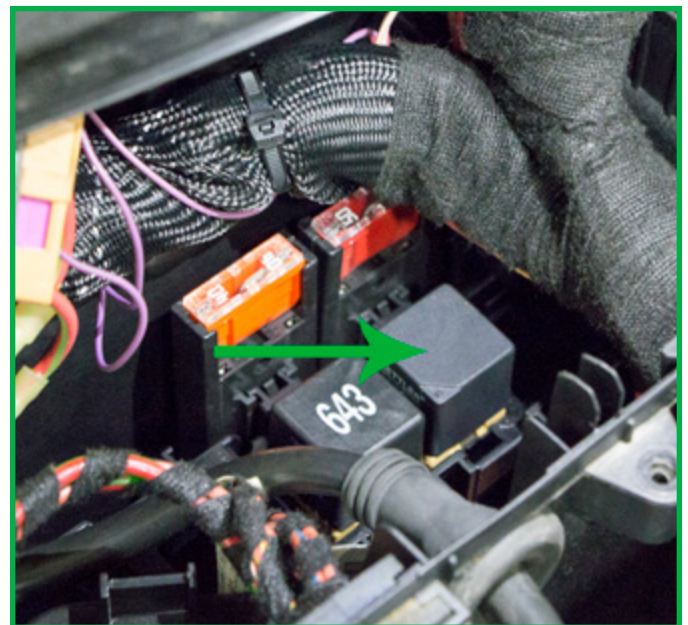

05-11 AUDI A6 (C6)
Relay located on the left side of the vehicle under the wiper cowl.

P-2462

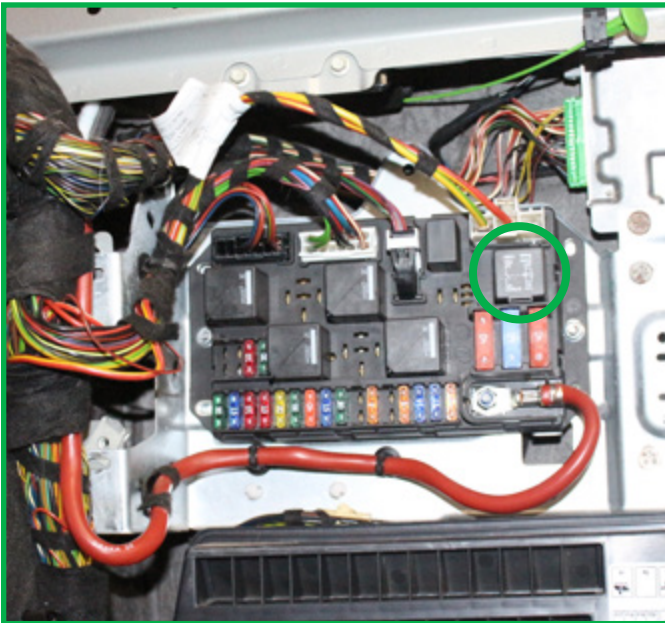

03-05 LAND ROVER RANGE ROVER (L322)
Relay located on the rear right fuse box.

P-2494

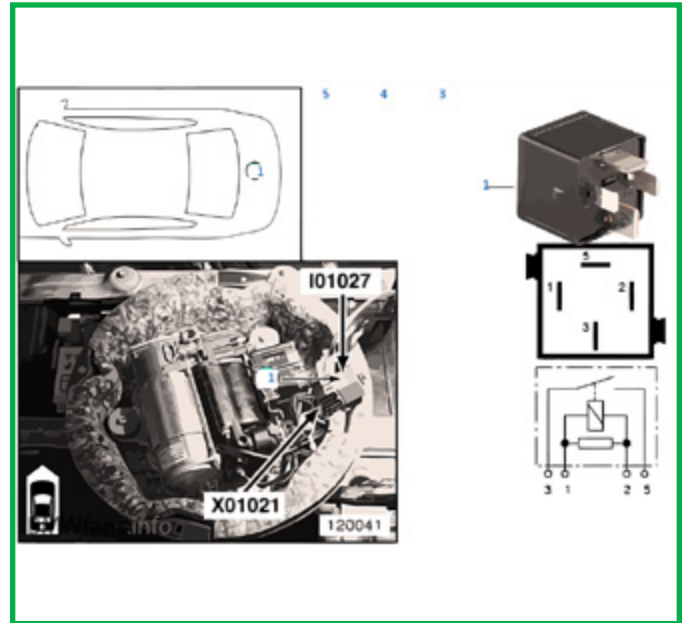

00-06 BMW X5 (E53, W/4-CORNER LEVELING)
Relay is mounted to the compressor.

P-2469

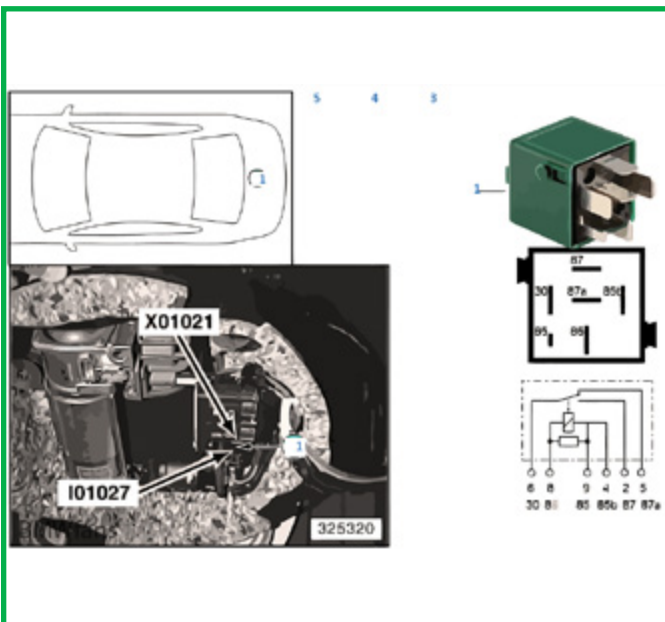

99-03 BMW 5 SERIES (E39)
Relay is mounted to the compressor.

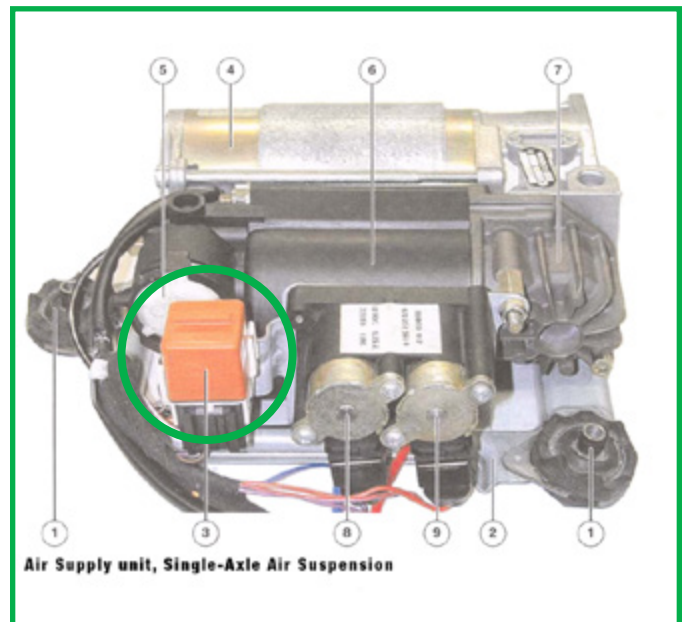

02-08 BMW 7 SERIES (E65, E66)
Relay is mounted to the compressor.

P-2495



98-04 LAND ROVER DISCOVERY II (L318)
Relay located within Underhood Fuse Block.

P-2496/P-3298/P-3304

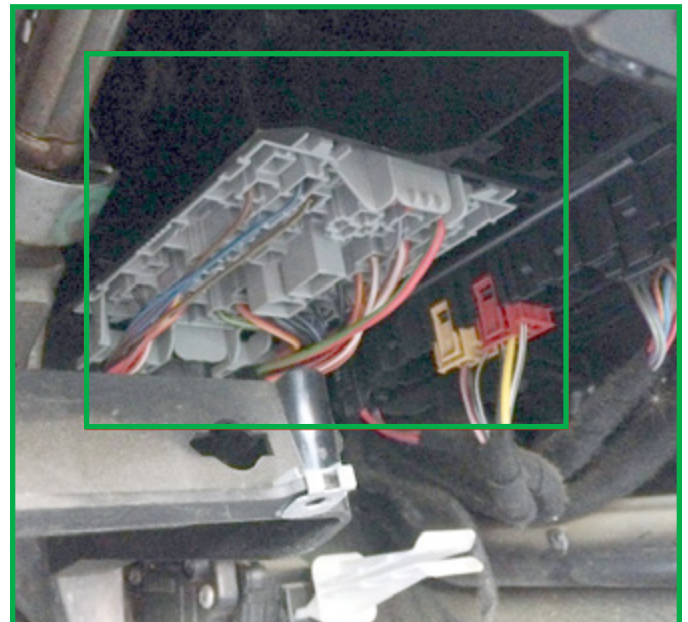
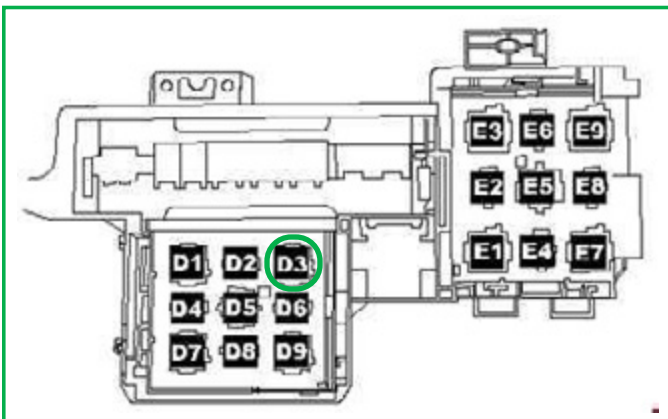

04-10 VOLKSWAGEN TOUAREG (7L)
Relay located under the drivers side dashboard.

P-2496/P-3298/P-3304

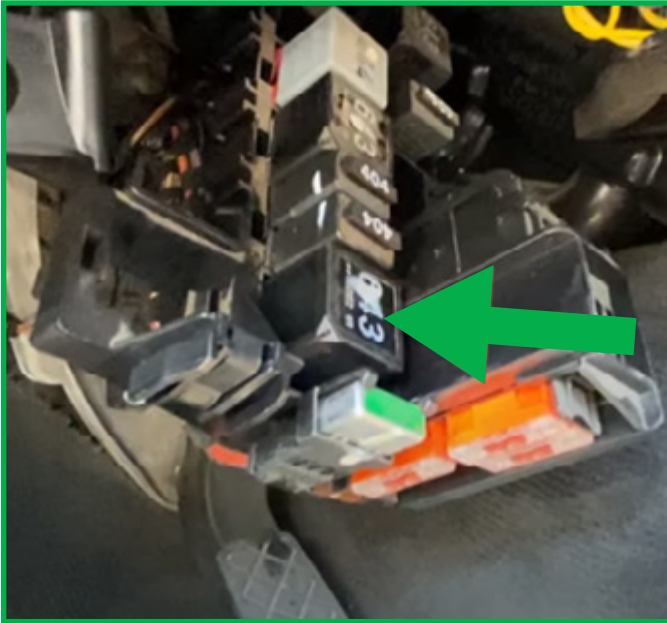

07-15 AUDI Q7 (4L)
Relay located under the drivers side dashboard.

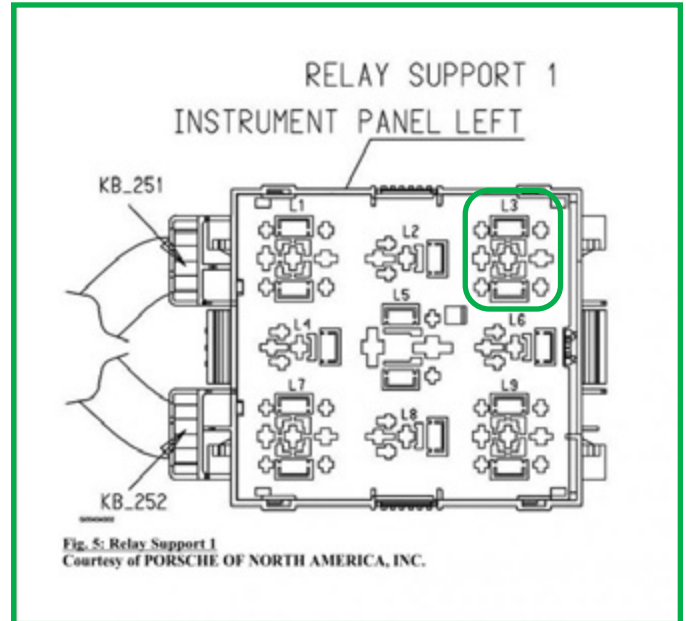

03-10 PORSCHE CAYENNE (9PA)
Relay located under the drivers side dashboard (Position L3).

P-2740



03-19 BENTLEY CONTINENTAL GT/06-19 FLYING SPUR (D1)
Relay located in rear left of the trunk, above the battery.

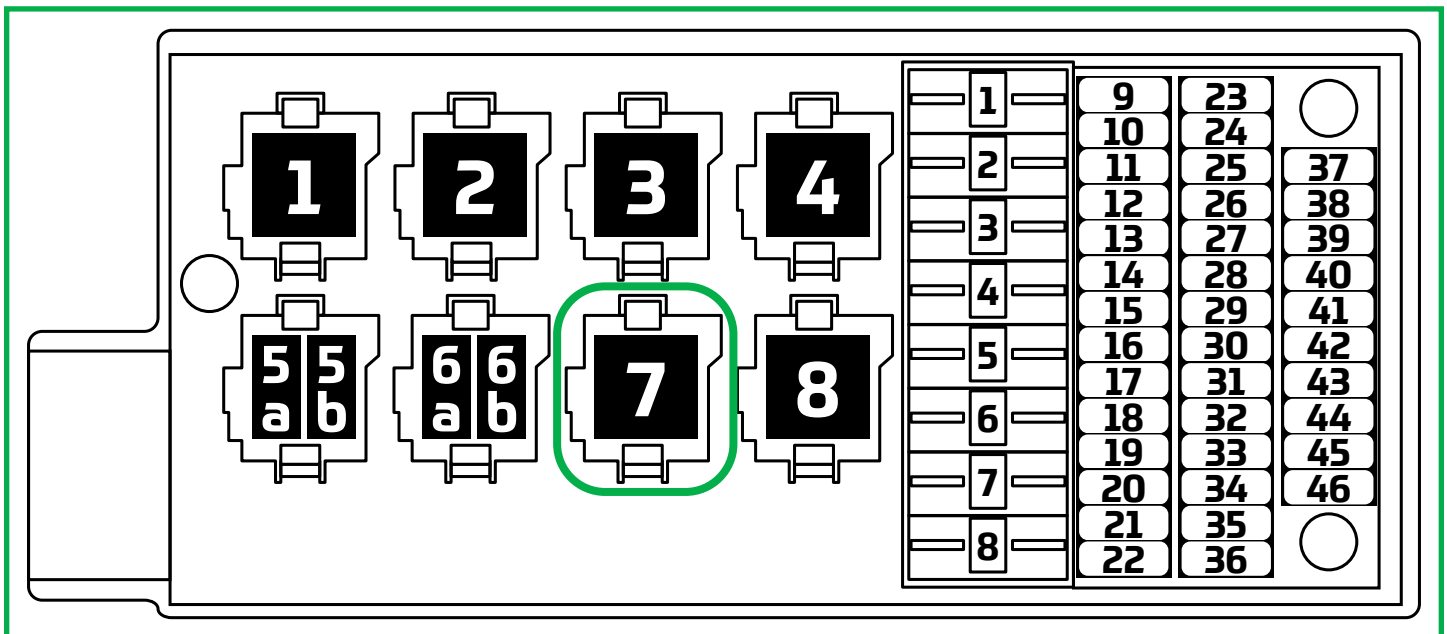

03-06 VOLKSWAGEN PHAETON (D1)
Relay located in luggage compartment on the left side.

Arnott™

Suspension Products

Arnott US Business Office:

www.arnottinc.com

100 Sea Ray Drive
Merritt Island, FL 32953

Call: 800.251.8993

321.868.3016

Fax: 321.868.3703

Email: techassistance@arnottinc.com

Arnott Europe Business Office:

www.arnotteurope.com

Docterskampstraat 1E/1F, 3
5222 AM 's-Hertogenbosch (NL)

NL Phone: +31 73 7850 580

DE Phone: +31 85 2087 438

UK Phone: +44 203 3186 124

BE Phone: +32 258 846 90

ES Phone: +34 91 901 10 56

FR Phone: +32 78 48 46 93

Email: info@arnotteurope.com



Air Springs

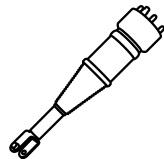

Struts

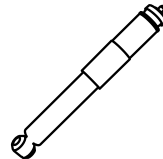

Shocks

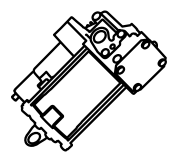

Compressors

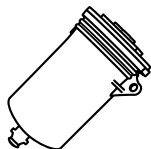

Dryers

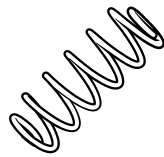

Coil Spring
Conversion Kits

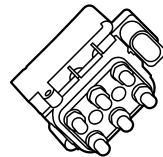

Valve Blocks

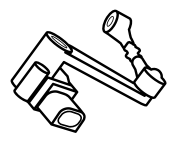

Ride Height
Sensors