

MIN THK 22.4 MM

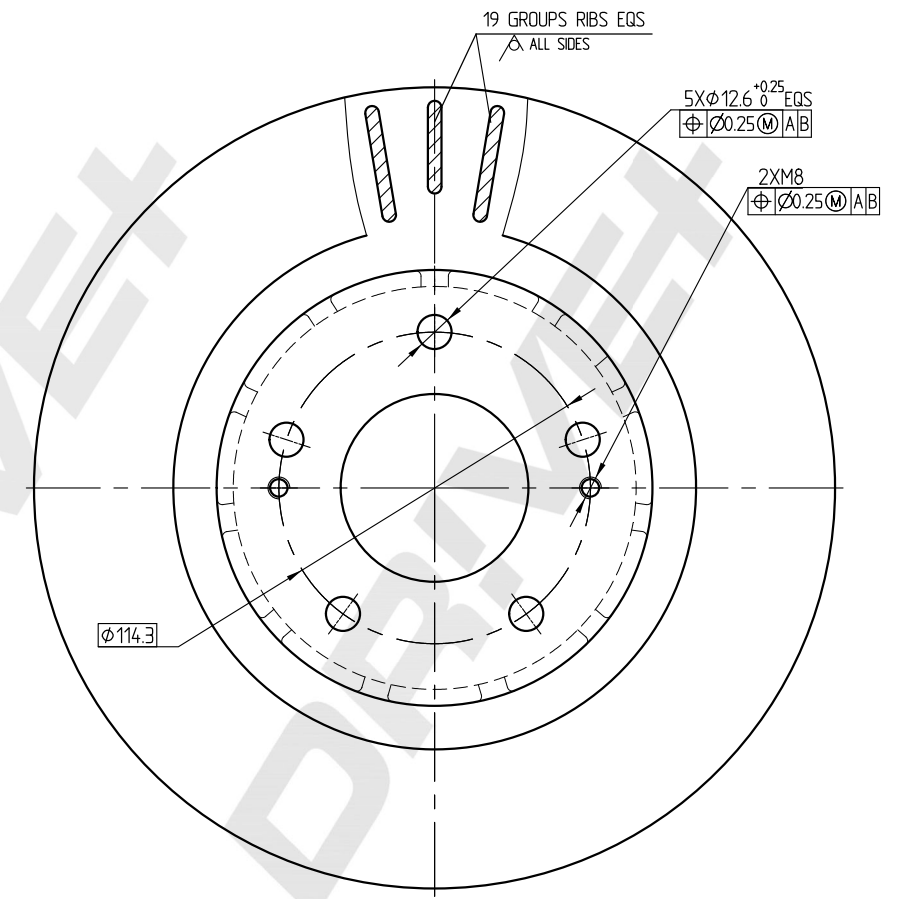

DP Number	Part Number	Drawing Version Number	Drawing Issue Date	DR!VET
DP1010.11.0425	DBD0425	V1	2025.04.13	