

BEARING1

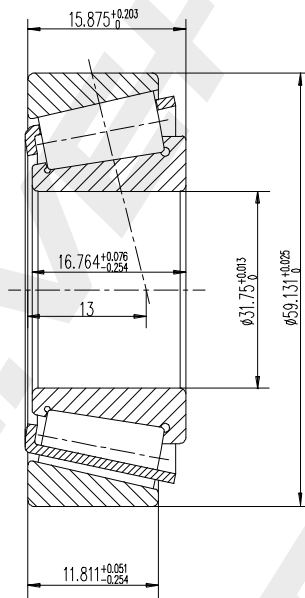

BEARING2

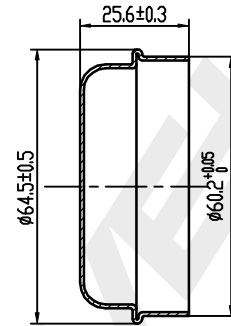

CAP  
1pcs Galvanizing

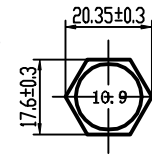

BOLT  
2pcs Galvanizing

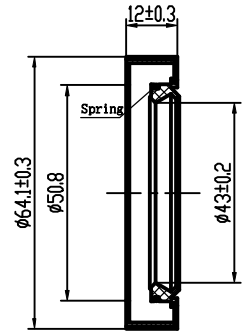
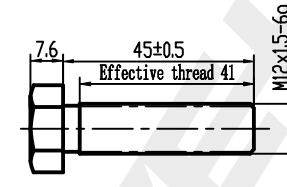

SEAL  
1pcs

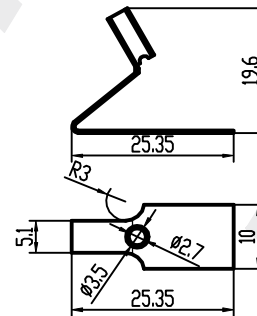

Spring  
1pcs Brass

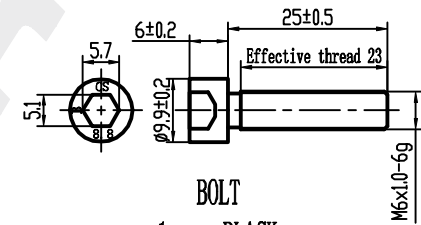

BOLT  
1pcs BLACK

DP Number	Part Number	Drawing Version Number	Drawing Issue Date
DP2010.10.0224	DRW0224	V1	2025.07.15

